



# COMPONENTS & MATERIALS CATALOG



# WE ARE PROTEOR

At **PROTEOR**, we are in constant pursuit of innovation with the best possible clinical outcomes in mind.

Keeping **#HumanFirst** as our mantra for over 100 years, **PROTEOR** is committed to delivering the most comprehensive prosthetic portfolio in the industry.

Our diverse and progressive patient solutions include everything today's prosthesis wearer needs to **LIVE THE LIFE THEY LOVE.**

## TABLE OF CONTENTS

<b>L-Code Chart</b> .....	<b>4</b>
<b>Microprocessor Full-Leg System</b> .....	<b>5</b>
SYNSYS .....	6
<b>Knees</b> .....	<b>8</b>
PROTEOR QUATTRO™ .....	9
Plié® 3 .....	10
ALLUX™ 2 .....	11
Symphony .....	12
HyTrek .....	13
Matik .....	14
1M Series .....	15
1M102 Series .....	16
1M112 Series .....	17
EasyRide .....	18
<b>Ankles</b> .....	<b>19</b>
PROTEOR Kinnex™ 2.0 .....	20
Kinterra® .....	21
<b>Feet</b> .....	<b>22</b>
ShockWave™ .....	24
RUSH ROGUE® 2 .....	25
RUSH HiPro® .....	26
RUSH ROVER® .....	27
Highlander® / Highlander® MAX .....	28
RUSH Chopart .....	29
Agilix .....	30
RUSH RAMPAGE® .....	31
RUSH RAMPAGE® LP .....	32
Sierra® .....	33
Pacifica® / Pacifica® LP .....	34
DynAdapt .....	35
RUSH Kid® .....	36
RUSH H2O Collection .....	37
RUSH EVAQ8® Collection .....	38
EVAQ8 Collection .....	39
EasyRun .....	40
Gery .....	41
DynaStep .....	42
Foot Shells & Spectra Socks .....	43
<b>Digital</b> .....	<b>45</b>
Orten .....	46
<b>Components</b> .....	<b>48</b>
<b>Socket Technology</b> .....	<b>58</b>
<b>Materials &amp; Fabrication</b> .....	<b>73</b>
<b>Ordering, Returns, Warranty Policies</b> .....	<b>86</b>



**Easy online  
ordering.**

24 hours a day.  
7 days a week.

Create your account at  
**shop.proteorusa.com**



# L-CODE CHART

Feet	Item #	K-Level	L-Code(s)
Gery	1A200	K1-K2	L5972
Agilix	F15	K3	L5987, L5986
DynaStep* (w/multi-axis ankle*)	1A101	K3	L5981*, (L5986*)
DynAdapt	F10	K3	L5980, L5986
Highlander* & Highlander MAX	FS3	K3	L5981*
Pacifica LP	FS4	K3	L5981
Pacifica	FS2	K3	L5981
RUSH Chopart*	CHO	K3-K4	L5976* (RUSH 76)
RUSH HiPro*	HiP	K3-K4	L5981* (RUSH 87)
RUSH Kid	KID	K3-K4	L5981
RUSH RAMPAGE LP	RAMLP	K3-K4	L5981, L5986
RUSH RAMPAGE	RAM	K3-K4	L5987, L5986
RUSH ROGUE 2*	ROG2	K3-K4	L5987*, L5984*
RUSH ROVER*	ROV	K3-K4	L5981*
ShockWave*	F20	K3-K4	L5987*, L5984*
Sierra	FS1	K3-K4	L5981, L5986
<b>Vacuum Options</b>			
RUSH HiPro EVAQ8	EVQH	K3-K4	L5981, L5781
RUSH RAMPAGE EVAQ8	EVRAM	K3-K4	L5987, L5986, L5781
RUSH RAMPAGE LP EVAQ8	EVQRAML	K3-K4	L5981, L5986, L5781
RUSH ROGUE 2 EVAQ8*	EVQR2	K3-K4	L5987*, L5984*, L5781
SHOCKWAVE EVAQ8	F20-V2	K3-K4	L5987, L5984, L5781
AGILIX EVAQ8	F15-V2	K3	L5987, L5986, L5781
SIERRA EVAQ8	FS1-V2	K3-K4	L5981, L5986, L5781
HIGHLANDER EVAQ8	FS3-V2	K3	L5781
DYNADAPT EVAQ8	F10-V2	K3	L5980, L5986, L5781
<b>Water Feet</b>			
RUSH HiPro H2O	H2H	K3-K4	L5981
RUSH RAMPAGE H2O	H2RAM	K3-K4	L5987, L5986
RUSH RAMPAGE LP H2O	H2RAMLP	K3-K4	L5981, L5986
RUSH ROGUE 2 H2O*	H2R2	K3-K4	L5987*, L5984*
<b>Sport Specific</b>			
EasyRun	1A920	K4	L5980

Microprocessor Full-Leg System	Item #	K-Level	L-Code(s)
SYNSYS	1P700LEG	K3	L5828*, L5856*, L5845*, L5848*, L5850*, L5925*, L5973*
<b>Knees/Ankles</b>			
<b>Hydraulic Ankle</b>			
Kinterra*	RM3	K3	L5981*, L5968*
Kinterra EVAQ8	RM3-V2	K3	L5981, L5968, L5781
<b>Microprocessor Ankle</b>			
PROTEOR Kinnex 2.0*	F14-N2	K3	L5973*
<b>Microprocessor Knee</b>			
ALLUX 2 4-Bar MPK*	NE-Z41/SH	K3	L5615*, L5856*, L5845* and L5848*
Plié 3*	KS3/KD3	K3-K4	L5828*, L5856*, L5845*, L5848*, L5850*
PROTEOR QUATTRO*	QNX0010/ QNX0011	K3-K4	L5856*, L5828*, L5848*, L5845*, L5850*, L5925*
<b>Mechanical Knees</b>			
Single-Axis CF Locking	1M01/1M10	K1	L5811
4-Axis Adjustable Linkage	1M05	K1-K2	L5611, L5850
4-Axis Knee Long Linkage	1M102/P6	K1-K2	L5611, L5850
4-Axis Knee Long Linkage - w/Lock	1M102V/P6	K1-K2	L5611, L5850, L5925
Compact 4-Axis Knee	1M112/1M113	K2	L5611, L5850
Advanced Pneumatic Knee	NK-1H	K3	L5822, L5930(K4)
Advanced Pneumatic Knee w/Ext. Assist	NK-1HS	K3	L5822, L5850
Matik 4-Axis Pneumatic Knee	1P200/KD	K3	L5840, L5850
HyDeal II Hydraulic 4-Bar Knee - Grey Pyramid Top	1P120/KD	K3-K4	L5613, L5850
HyDeal II Hydraulic 4-Bar Knee - Orange Pyramid Top	1P121/KD	K3-K4	L5613, L5850
HyTrek	1P131/KD	K3-K4	L5828, L5845, L5850, L5925
Symphony - 6-Axis Hydraulic Knee w/Lock	NK-6/SH+L	K3	L5814, L5845, L5848, L5850, L5925
Symphony - 6-Axis Hydraulic Knee	NK-6/SH	K3	L5814, L5845, L5848, L5850
EasyRide Sport Knee	1P650	K4	L5830, L5845, L5848, L5850, L5925, L5930
<b>Hybrid Knees</b>			
Hybrid Knee (Intelligent Knee +Stance Yielding)	NI-C311/ NI-C313	K3-K4	L5828, L5830, L5857

## \*PDAC verified

The responsibility for accurate coding lies with the patient care facility that selects the product, fits the patient, and bills for the service. The product/device "Supplier", defined as an O&P practitioner, O&P patient care facility, or DME Supplier, assumes full responsibility for accurate billing of PROTEOR products. It is the Supplier's responsibility to determine medical necessity; ensure coverage criteria is met; and submit appropriate HCPCS codes, modifiers, and charges for services/products delivered. It is also recommended that Supplier's contact insurance payer(s) for coding and coverage guidance prior to submitting claims. PROTEOR Coding Suggestions and Reimbursement Guides are based on reasonable judgment and are not recommended to replace the Supplier's judgment. These recommendations may be subject to revision based on additional information or alpha-numeric system changes.

# FULL-LEG SYSTEM

TABLE OF CONTENTS

Get more info by clicking on pictures



SYNSYS  
MICROPROCESSOR FULL-LEG SYSTEM



reddot award  
product design 2023

CONTACT US

ORDER



1236 West Southern Avenue #101, Tempe, AZ 85282 • 855.450.7300

[shop.proteorusa.com](https://shop.proteorusa.com)     #HumanFirst

#HUMANFIRST



# SYN SYS

MICROPROCESSOR FULL-LEG SYSTEM

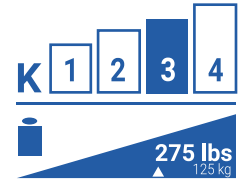

FULL-LEG SYSTEM

## AN ENTIRELY NEW ANGLE

Only **SYN SYS** Microprocessor Full-Leg System offers **triple flexion movements**, unlocking an entirely new angle on performance for low to moderate K3 patients.

### An Entirely New Angle On:

**Motion:** Only **SYN SYS** provides hip-knee-ankle **triple flexion** with 125° knee flexion and 42° ankle ROM to move freely like never imagined

**Stability:** **92% greater flat-foot time** for greater stability and **2x more toe clearance** for optimal security†

**Life:** Greater confidence with more shoe options, longer battery life, and ease while walking

### Ordering Information:

- Certifications are required before placing orders independently (for new patient trials and purchases)
- Certification courses are provided by the PROTEOR Clinical team and are free of charge
- Patients are required to trial prior to purchasing



L5828	L5856
L5845	L5848
L5973	L5850
L5925	



reddot award  
product design 2023



Programmable via  
**SYN SYS Soft App**  
for Prosthetists

Adjustable via  
**SYN SYS App**  
for Users



PROTEOR survey of 330 amputees, T1 2021.

†Requena, C et al. (2023, September 18). Increased of stability and security in transfemoral amputees with a knee-ankle synergistic system. Presented at ESMAC. Athens, Greece.

DOWNLOAD PRODUCT SHEET



CONTACT US

ORDER



1236 West Southern Avenue #101, Tempe, AZ 85282 • 855.450.7300

shop.proteorusa.com #HumanFirst

#HUMANFIRST



# SYNSYS

MICROPROCESSOR FULL-LEG SYSTEM

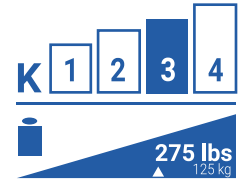

FULL-LEG SYSTEM



L5828 L5856  
L5845 L5848  
L5973 L5850  
L5925



red dot award  
product design 2023



## TECHNICAL FEATURES

Item N°	1P700LEG
Weight	3220g / 7.1lbs
Knee-to-ground Height	16.9" to 21.7" / 430 to 550mm
Knee Flexion	125°
Ankle ROM	42° (20° dorsiflexion / 22° plantarflexion)
Proximal Connector	Pyramid
Max Patient Weight	275lbs / 125kg
Activity Level	Low to moderate K3
Battery Life	>10 days depending on activity. Complete recharge time of 6 hours
CP Programming	iPad Pro 12.9" (5th generation), Windows 10 and 11
Patient App	iOS and Android
Water Resistance	IP54
Foot Sizes	23cm to 30cm
Foot Shell Colors	Light, Medium, Black

\*Not suitable for bilateral femoral or disarticulated hip amputees.

### Category Selection according to activity and weight

Weight/ Activity level	99-130lbs 45-59kg	131-163lbs 60-74kg	164-196lbs 75-89kg	197-229lbs 90-104kg	230-275lbs 105-125kg
Normal	1	2	3	4	5
High	2	3	4	5	-

## SYNSYS Protection Covers



Lightweight, hygienic, and easy-to-maintain protection that is included with each purchase.

Available in **24 colors**, plus a raw material finishing for patient customization.



DOWNLOAD PRODUCT SHEET



CONTACT US

ORDER



1236 West Southern Avenue #101, Tempe, AZ 85282 • 855.450.7300

shop.proteorusa.com #HumanFirst

#HUMANFIRST

# KNEES

## TABLE OF CONTENTS



PROTEOR  
**QUATTRO**<sup>™</sup>  
MICROPROCESSOR KNEE



**PLIÉ3**<sup>®</sup>  
MICROPROCESSOR KNEE



**ALLUX2**



*Symphony*



**HYTREK**



**matik**



**1M**  
SERIES



**1M102**  
SERIES



**1M112**  
SERIES



**easy**  
RIDE

CONTACT US

ORDER



PROTEOR  
**QUATTRO**<sup>™</sup>  
 MICROPROCESSOR KNEE

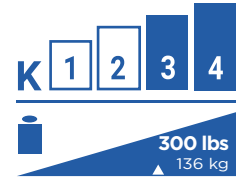

KNEES

### Expect More

Engineered to exceed expectations. The **PROTEOR QUATTRO**<sup>™</sup> Microprocessor Knee is designed to be more intuitive, more personalized, and more adaptable. With patented valve technology, advanced customization options, and remote updates, the **QUATTRO** gives you more of exactly what you need to live the life you want.

- More intuitive for elevated security and dependability: Patented valve control technology provides effortless transitions between activities. Three hyper-responsive sensors read body movements and advanced stumble recovery determines appropriate resistance to recover more naturally.
- More personalized for a custom experience: Up to 20 customizable modes. Clinician and patient apps streamline set up, monitoring, customization, and cadence reporting. The shortest MPK available provides a wider selection of ankles and feet.
- More adaptable for fewer interruptions: Battery life of over 2 days. An available booster pack (sold separately) allows patients to charge on the go. Water-resistance (IP67 rating) for full submersion (up to 1 m for 30 min). No service interval for 3 years. Remote firmware updates and transmission of cadence data.



L5828 L5850  
 L5845 L5856  
 L5848 L5925

#### TECHNICAL FEATURES

Item N°.	QNX0010	QNX0011
Weight	1655g / 3.65lbs	
Build Height	8.5" / 216mm	
Knee Flexion	135°	
Proximal Connector	Pyramid	Threaded Top
Maximum Patient Weight	300lbs / 136kg	
Activity Level	K3 / K4	
Battery Life	+2 Days	
Water Resistance	IP67	
External Battery Booster Pack	ACC0010	

Programmable via  
**GaitLab App**  
 for Prosthetists  
 (iOS and Android)

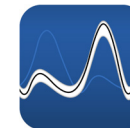

Adjustable via  
**Freedom Innovations App**  
 for Users  
 (iOS and Android)



DOWNLOAD PRODUCT SHEET



CONTACT US

ORDER



1236 West Southern Avenue #101, Tempe, AZ 85282 • 855.450.7300

shop.proteorusa.com #HumanFirst

#HUMANFIRST



# PLIÉ3<sup>®</sup>

## MICROPROCESSOR KNEE

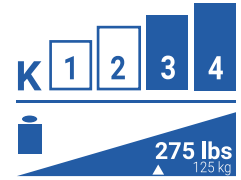

KNEES

### A Fundamental Fit

Empowering patients with dependable performance and essential functionality. The **Plié<sup>®</sup> 3** Microprocessor Knee is a dependable knee that's versatile enough for anywhere your low, moderate, or high K3 patients want to go.

- Streamlined design with rugged internal components and modern aesthetics
- Quickly responds, adapting to a variety of gait speeds and changes in user activities
- Customizable stumble recovery parameters
- Manual adjustments available to optimize activities
- Interchangeable batteries for on-the-go convenience
- IP67 rating for full submersion in water
- Generation of cadence reports



L5828 | L5850  
L5845 | L5856  
L5848

### TECHNICAL FEATURES

Item N°.	KS3-00-KNEE1-KT	KD3-00-KNEE2-KT
Weight	1235g / 2.7lbs	1243g / 2.4lbs
Build Height	9.25" / 235mm	8.75" / 223mm
Knee Flexion	125°	117°
Proximal Connector	Pyramid	Threaded Top
Maximum Patient Weight	275lbs / 125kg moderate activity 220lbs / 100kg high activity	
Activity Level	K3 / K4	
Battery Life	24 hours per battery (2 interchangeable batteries included)	
Water Resistance	IP67	

### Fairing Options



DOWNLOAD PRODUCT SHEET



CONTACT US

ORDER



1236 West Southern Avenue #101, Tempe, AZ 85282 • 855.450.7300

shop.proteorusa.com #HumanFirst

#HUMANFIRST



# ALLUX<sup>TM</sup> 2

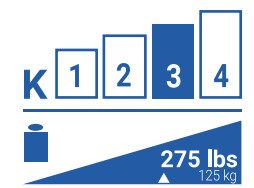

KNEES

## Elevating Confidence

Exceptional functionality for patients seeking confidence on their prosthesis. The **ALLUX<sup>TM</sup> 2** Microprocessor Knee is the world's first four-bar linkage knee with an added layer of stability to ensure optimal security.

- Industry-leading range of motion provides increased toe clearance
- Five walking modes allow for greater personalization
- Improved sitting cosmesis for patients with long residual limbs
- Convenience of wireless programming via Bluetooth connectivity
- Long-lasting battery life up to four days plus back-up booster



L5848 | L5856  
L5845 | L5615

### TECHNICAL FEATURES

Item N°.	NE-Z41	NE-Z41SH
Weight	1510g / 3.3lbs	1520g / 3.4lbs
Build Height	11.5" / 295mm	11.3" / 287mm
Knee Flexion	180°	
Proximal Connector	Pyramid	Threaded Top
Maximum Patient Weight	275lbs / 125kg	
Activity Level	Low to moderate K3	
Battery & Supplemental Backup Battery	Lithium Ion	
Water Resistance	IP44	

Programmable via **Adjustment App** for Prosthetists (iOS and Android)

Adjustable via **Remote Control App** for Users (iOS and Android)



DOWNLOAD PRODUCT SHEET



CONTACT US

ORDER



1236 West Southern Avenue #101, Tempe, AZ 85282 • 855.450.7300

shop.proteorusa.com #HumanFirst

#HUMANFIRST

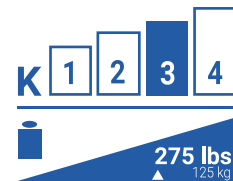

## Fluidity, Functionality, Safety; A Perfect Composition

The **Symphony** Knee is designed with a unique, 6-Bar polycentric structure that provides an extremely high level of stability during stance phase. The innovative p-MRS system, automatically detects gait status and controls the stability of the knee joint accordingly. The hydraulic cylinder provides a smooth swing phase and works with the **Symphony's** adjustable stance flexion feature to enhance the patient's ambulatory experience and provide a comfortable, confident gait to the user.



- 6-Bar hydraulic knee
- Adjustable stance flexion
- Only polycentric knee with an optional manual lock
- High level of stability due to geometric locking of the knee through toe off
- Low build height
- Unique hydraulic cylinder design allows easy flexion initiation

### TECHNICAL FEATURES

Item N°.	NK-6	NK-6+L	NK-6 SH	NK-6 SH+L
Weight	920g / 2.0lbs	970g / 2.1lbs	960g / 2.1lbs	1010g / 2.2lbs
Build Height	7.7" / 197mm		7.5" / 191mm	
Knee Flexion	170°			
Proximal Connection	Pyramid		Threaded Top	
Maximum Patient Weight	275lbs / 125kg 220lbs / 100kg for Hip Prosthesis & Highly Active Use			
Activity Level	K3			
Selective Lock	No	Yes	No	Yes



DOWNLOAD PRODUCT SHEET



CONTACT US

ORDER



1236 West Southern Avenue #101, Tempe, AZ 85282 • 855.450.7300

shop.proteorusa.com #HumanFirst

#HUMANFIRST

# HYTREK

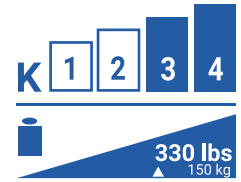

KNEES

## Single Axis With Hydraulic Regulation of Stance and Swing Phases And Manual Lock

The **Hytrek** is a durable knee for dynamic transfemoral amputees. Navigate everyday life activities on all types of terrain; including slopes and stairs. Offers smooth ambulation and the ability to safely descend stairs step over step.

- Adjustable hydraulic resistance for supported stair decent
- Optional manual lock
- Extension assist
- Requires 34mm Pylon Distal Connectivity (sold separately)



- STANCE:** Adjustment of sensitivity for switching to braking mode.
- RESISTANCE:** Adjustment of braking power.
- LOCK:** Manual hydraulic lock switch.
- FLEXION:** Adjustment of flexion angle.
- EXTENSION:** Dynamic control of swing phase and terminal impact.

### TECHNICAL FEATURES

Item N°.	1P131	1P131-KD
Weight	1265g / 2.8lbs	1285g / 2.8lbs
Build Height	7.0" / 177mm	6.9" / 174mm
Knee Flexion	120°	
Proximal Connector	Pyramid	Threaded Top
Distal Connector	34mm	
Maximum Patient Weight	330lbs / 150kg	
Activity level	K3 / K4	
Water Resistance	Weather resistant	
Materials	Aluminum, Stainless steel, Titanium	

1X998 To avoid spoiling the pyramid during trials

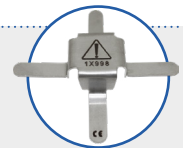

DOWNLOAD PRODUCT SHEET



CONTACT US

ORDER



1236 West Southern Avenue #101, Tempe, AZ 85282 • 855.450.7300

shop.proteorusa.com #HumanFirst

#HUMANFIRST



KNEES

# matik

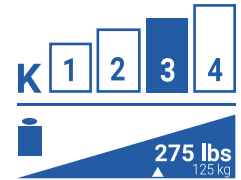

## An Affordable 4-axis Pneumatic Knee For Patients Up To 275lbs

Simply and effectively designed to provide high function with low maintenance. The easy swing of the pneumatic unit and the reduced weight of the knee give the patient a heightened sensation of fluidity and comfort. To support safety during swing phase and reduce the risk of a fall, the toe clearance during swing reaches up to 25mm, one of the largest clearances for this type of knee. **Matik** has both flexion and extension adjustments which address terminal impact and heel rise.

- Pneumatic knee with an adjustable extension assist
- Secure 4-axis geometry
- Safety and security through generous toe clearance during swing phase
- Compact and lightweight



### TECHNICAL FEATURES

Item N°	1P200	1P200-KD
Weight	743g / 1.6lbs	
Build Height	6.9" / 175mm	6.9" / 175mm
Knee Flexion	170°	
Proximal Connector	Pyramid	Threaded Top
Distal Connector	Pyramid	
Maximum Patient Weight	275lbs / 125kg	
Activity Level	Low to moderate K3	
Materials	Aluminum, Stainless steel	



CONTACT US

ORDER



# 1M SERIES

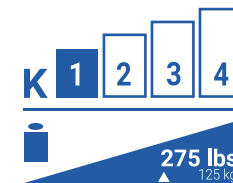

KNEES

## Convenient Lock Ensures Patient Safety While Walking

- Joint friction adjustment
- Lock with adjustable stop
- Socket rotation adjustment:  $\pm 15^\circ$
- 1M01 / 1M10 require 30mm pylon distal connectivity
- 1M01-HD / 1M10-HD require 34mm pylon distal connectivity



### TECHNICAL FEATURES

Item N°.	Max. Patient Weight	Weight	TH	BH	H	Materials	Release lever	Flexion	Distal Connector
1M01	220lbs/ 100kg	345g/ 0.8lbs	3.9"/ 99mm	2.3"/ 58mm	0.5"/ 13mm	Aluminum Steel	No	130°	Ø 30mm
<b>1M10</b>		355g/ 0.8lbs					<b>Yes</b>		
1M01-HD	275lbs/ 125kg	375g/ 0.8lbs	4.0"/ 102mm	2.3"/ 59mm	0.6"/ 14mm		No		Ø 34mm
<b>1M10-HD</b>							<b>Yes</b>		

1M01 / 1M10

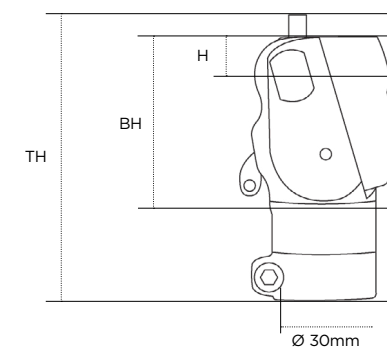

1M01-HD / 1M10-HD

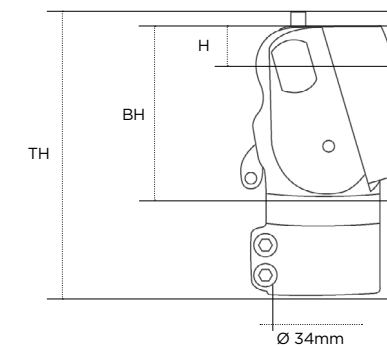

### PROXIMAL ADAPTERS REQUIRED TO COMPLETE YOUR ORDER



1K40

1K160-HD

1K160

1K163



CONTACT US

ORDER



1236 West Southern Avenue #101, Tempe, AZ 85282 • 855.450.7300

shop.proteorusa.com #HumanFirst

#HUMANFIRST



# 1M102 SERIES

K 1 2 3 4

275 lbs  
125 kg

KNEES

## Unique Alignment and Axis Geometry Offers Increased Safety During Stance Phase

- Socket rotation adjustment:  $\pm 15^\circ$
- Friction adjustment
- Extension assist adjustment
- Optional lock available
- 1M02 / 1M102V require 30mm pylon distal connectivity
- 1M02-HD / 1M102V-HD require 34mm pylon distal connectivity



### TECHNICAL FEATURES

Item N°.	Max. Patient Weight	Weight	TH	BH	H	Material	Lock	Flexion	Distal Connector
1M102	220lbs/ 100kg	565g/ 1.2lbs	7.2"/ 184mm	4.4"/ 113mm	0.5"/ 14mm	Aluminum	No	160°	Ø 30mm
<b>1M102V</b>		575g/ 1.3lbs					<b>Yes</b>		
1M102-HD	275lbs/ 125kg	500g/ 1.1lbs					No		Ø 34mm
<b>1M102V-HD</b>		525g/ 1.2lbs					<b>Yes</b>		
1X110	(required for 1M102V / 1M102V-HD) Socket Mounted Mechanical Knee Lock Release								

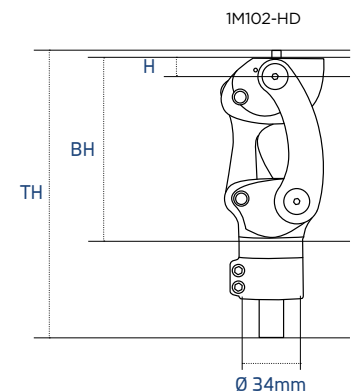
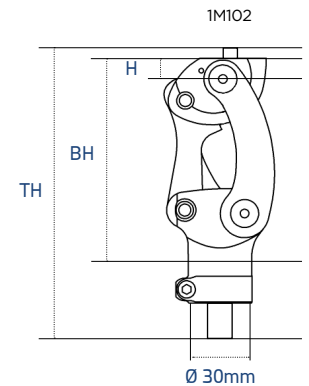

### PROXIMAL ADAPTERS REQUIRED TO COMPLETE YOUR ORDER



CONTACT US

ORDER





# 1M112 SERIES

K 1 2 3 4

176 lbs  
80 kg

KNEES

## Compact 4-axis Knee

- Socket rotation adjustment:  $\pm 15^\circ$
- Friction adjustment
- Extension assist adjustment
- Safety in stance phase ensured by alignment and axis geometry
- The 4-axis and linkage geometry provides a shortening of the leg segment during swing phase
- 1M112 requires 22mm pylon distal connectivity
- 1M113 requires 30mm pylon distal connectivity

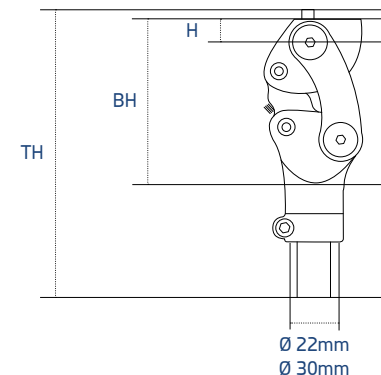

### TECHNICAL FEATURES

	Item N°.	Max. Patient Weight	Weight	TH	BH	H	Material	Flexion	Distal Connector
Peds	1M112	99lbs / 45kg	320g / 0.7 lbs	6.1" / 155mm	3.0" / 75mm	0.4" / 11mm	Aluminum	165°	Ø 22mm
	1M113	176lbs / 80kg							Ø 30mm

### PROXIMAL ADAPTERS REQUIRED TO COMPLETE YOUR ORDER



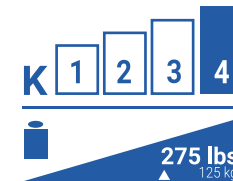

KNEES

## High Impact Multi-sport Knee

The **EasyRide** knee was created in collaboration with adaptive athletes from around the world to ensure optimal performance capabilities for extreme, high impact, and all-terrain sports such as surfing, snowboarding, skateboarding, cycling, skiing, and more. The **EasyRide** lets you get back to the activities you LOVE without limitations.

### Durability and Safety

- The FOX® shock absorber smoothly reproduces the natural motion of the knee and ensures smooth energy return
- Aeronautical-grade aluminum alloy and custom hardening treatment withstands most extreme conditions including saltwater and cold temperatures
- Lightweight, sturdy design

### Adaptability

- Customizable for optimal function depending on type of sport, requiring knee flexion
- Adjusts to 12° pre-flexion / 60° max; biking position adjusted with 0° pre-flexion / 130° flexion max allowing for both good load transfer to the pedal and enough flexion for pedaling



#### TECHNICAL FEATURES

Item N°.	1P650
Weight	1264g / 2.3lbs
Build Height / Full Height Position A	9" - 10" / 227mm - 257mm
Position A Pre-flexion / Flexion / PreSSION	12° / 60° max / 4 to 20 bars
Build Height / Full Height Position B	9" - 10" / 230mm - 260mm
Position B Pre-flexion / Flexion / PreSSION	0° / 130° max / 1 to 6 bars
Proximal Connector	Pyramid
Distal Connector	Pyramid
Maximum Patient Weight	275lbs / 125kg
Activity level	K4

- Paddle-boarding
- Surfing
- Wind Surfing
- Water Skiing
- Wake Surfing
- Skiing (Downhill and Cross Country)
- Snowboarding
- Skateboarding
- Mountain Biking
- Road Biking
- And more...

1X998 To avoid spoiling the pyramid during trials

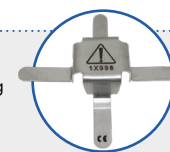

DOWNLOAD PRODUCT SHEET



CONTACT US

ORDER



1236 West Southern Avenue #101, Tempe, AZ 85282 • 855.450.7300

shop.proteorusa.com     #HumanFirst

#HUMANFIRST

# ANKLES

TABLE OF CONTENTS

Get more info by clicking on pictures



PROTEOR  
**KINNEX™ 2.0**  
MICROPROCESSOR ANKLE/FOOT SYSTEM



**KINTERRA®**



CONTACT US

ORDER



1236 West Southern Avenue #101, Tempe, AZ 85282 • 855.450.7300

[shop.proteorusa.com](http://shop.proteorusa.com)     #HumanFirst

#HUMANFIRST



PROTEOR  
**KINNEX™ 2.0**  
 MICROPROCESSOR ANKLE/FOOT SYSTEM

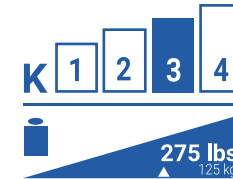

ANKLES

## Designed for my real life... without compromise

The **Kinnex 2.0** integrates the world's fastest responding microprocessor ankle/foot technology and carbon fiber footplate to provide low to moderate impact K3 ambulators the stability they expect – instantly. Unmatched ground compliance, improved comfort, and heel height adjustments keep users firmly grounded and connected, wet or dry.

- IP67 rated for water submersion up to 1m for 30 mins
- Sophisticated microprocessor controlled resistance helps optimize stability whenever changes in terrain or cadence occurs
- Accommodates heel heights from 0-2" and allows user to program up to 100 shoes
- 30° of microprocessor-controlled ankle range of motion: 20° plantar flexion / 10° dorsi flexion allows the ankle and foot to be ideally positioned in relation to the ground
- Split keel and heel for medial/lateral terrain adaptability
- Booster battery pack available for on-the-go charging

Programmable via  
**GaitLab App**  
 for Prosthetists  
 (iOS and Android)

Adjustable via  
**Freedom Innovations App**  
 for Users  
 (iOS and Android)

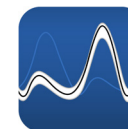

L5973

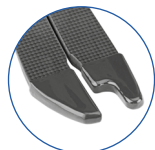

Sandal-toe available for sizes 24-28cm.

### TECHNICAL FEATURES

Item N°.	F14-N2	
Weight (26 Cat 4, module with foot shell and spectra sock)	1680g / 3.7lbs	
Build Height*	24 - 25cm	6.9" / 182mm
	26 - 28cm	7.0" / 178mm
	29 - 30cm	7.1" / 180mm
Standard Foot Shell (No CAP)	FTC-3K-1	
Sandal Toe Foot Shell (No CAP)	FTC-2K-1	

Spectra Sock and Heel Bumper Kit included.  
 Foot Shell must be ordered separately.

\*Build height based on size 24cm, 26cm, 29cm Cat 4 foot module with foot shell, spectra sock, and 10mm heel height. Sandal-toe available for sizes 24-28cm.

Module selection according to activity and weight								
Weight/Activity level	100-115lbs 44-52kg	116-130lbs 53-59kg	131-150lbs 60-68kg	151-170lbs 69-77kg	171-195lbs 78-88kg	196-220lbs 89-100kg	221-255lbs 101-116kg	256-275lbs 117-125kg
Low	1	1	2	3	4	5	6	7
Moderate	1	2	3	4	5	6	7	-

[DOWNLOAD PRODUCT SHEET](#)

CE
[CONTACT US](#)
[ORDER](#)



1236 West Southern Avenue #101, Tempe, AZ 85282 • 855.450.7300

shop.proteorusa.com #HumanFirst

#HUMANFIRST



# KINTERRA®

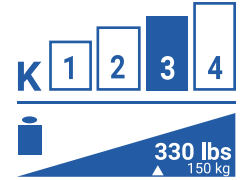

ANKLES

Now Available in  
**EVAQ8®**

## Redefining the Ankle Experience

The time-tested hydraulic ankle that continues to raise the bar for quality, stability, range of motion, and comfort.

- 17° Range of motion (2° DF/ 15° PF) for terrain adaptation and sitting comfort
- 330lb (150kg) user weight limit
- Submersible in fresh water up to 1m for 30 mins
- Completely redesigned hydraulic ankle and EnduraCore® full length footplate with split keel and heel
- Available in Sandal Toe only

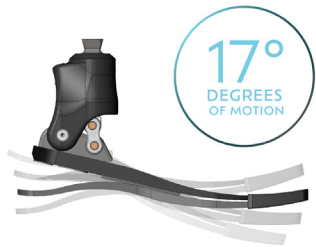

L5981 & L5968

Available in Sandal  
Toe Only

### TECHNICAL FEATURES

Item N°.		RM3
Weight (26 Cat 4, module with foot shell and spectra sock)		833g / 1.8lbs
Build Height*	22 - 25cm	4.65" / 118mm
	26 - 28cm	4.67" / 119mm
	29 - 30cm	4.81" / 122mm
Heel Height		3/8" / 10mm
Sandal Toe Foot Shell (No CAP)		FTC-2K-1

Black Spectra sock and Heel Bumper Kit included.  
Foot Shell must be ordered separately.

\*Build height based on size 23cm, 26cm, 29cm Cat 4 foot module with foot shell, spectra sock, and 10mm heel height.

Category selection according to activity and weight									
Weight/Activity level	100-115lbs 44-52kg	116-130lbs 53-59kg	131-150lbs 60-68kg	151-170lbs 69-77kg	171-195lbs 78-88kg	196-220lbs 89-100kg	221-255lbs 101-116kg	256-290lbs 117-132kg	291-330lbs 133-150kg
Low	1	1	2	3	4	5	6	7	8
Moderate	1	2	3	4	5	6	7	8	-

**The Kinterra 2.0 has been discontinued.** Please see pg. 42 for replacement footshells for Kinterra 2.0

DOWNLOAD PRODUCT SHEET



CONTACT US

ORDER



1236 West Southern Avenue #101, Tempe, AZ 85282 • 855.450.7300

shop.proteorusa.com #HumanFirst

#HUMANFIRST

# FEET

TABLE OF CONTENTS

Get more info by clicking on pictures



CONTACT US

ORDER

# FEET

## TABLE OF CONTENTS



CONTACT US

ORDER

# SHOCKWAVE®

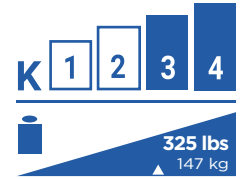

FEET

Now Available in  
**EVAQ8®**



L5987 & L5984

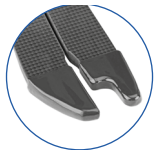

Sandal-toe available for sizes 23-28cm.

## Pure Excitement

Confidence for an active lifestyle—and the freedom to move as responsively as K3/K4 ambulators want to—are now possible with the premier **ShockWave™** carbon fiber foot from PROTEOR. Provides a shockingly smooth experience during high-impact activities, due to an advanced, multi-functional Spherical Shock Unit for ultimate vertical shock absorption.

- **Move More Naturally:** Allows a more natural gait by providing ultimate shock absorption at heel strike, which eases stress on the residual limb.
- **Seamless Movement:** Axial rotation of +/- 15° reduces socket pressure and allows for quick pivoting.
- **Trust Every Step:** Adds confidence when navigating diverse terrains with a split keel and heel to enable greater motion—improving stability and comfort.
- **Lasting Reliability:** Lighter, more reliable foot due to a bolt-less footplate design that eliminates dead spots and weak structural areas.
- **Enjoy More Activities:** Proprietary EnduraCore technology provides ideal strength, flexibility, and durability for high energy return with less fatigue.
- **Go More Places:** Available in sandal toe.
- **Water Resistant**

### TECHNICAL FEATURES

Item N°.	F20-S3
Weight (26 Cat4, module with foot shell and spectra sock)	978g / 2.2lbs
Build Height*	23 - 25cm 6.9" / 176mm
	26 - 28cm 7.4" / 189mm
	29 - 30cm 7.8" / 200mm
Heel Height	3/8" / 10mm
Standard Foot Shell (No CAP)	FTC-3F-1
Sandal Toe Foot Shell (No CAP)	FTC-2F-1

Black Spectra Sock and Heel Bumper Kit included in each Foot Module delivery.  
Foot Shell must be ordered separately.

\*Build height based on size 23cm, 26cm, 29cm Cat 4 foot module with foot shell, spectra sock, and 10mm heel height. Sandal-toe available for sizes 23-28cm.

Module selection according to activity and weight										
Weight/Activity level	100-115lbs 44-52kg	116-130lbs 53-59kg	131-150lbs 60-68kg	151-170lbs 69-77kg	171-195lbs 78-88kg	196-220lbs 89-100kg	221-255lbs 101-116kg	256-285lbs 117-130kg	286-325lbs 131-147kg	
Low	1	1	2	3	4	5	6	7	8	
Moderate	1	2	3	4	5	6	7	8	-	
High	2	3	4	5	6	7	8	-	-	

1X998 To avoid spoiling the pyramid during trials



DOWNLOAD PRODUCT SHEET



CONTACT US

ORDER



1236 West Southern Avenue #101, Tempe, AZ 85282 • 855.450.7300

shop.proteorusa.com #HumanFirst

#HUMANFIRST



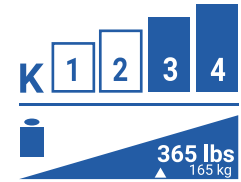

FEET

## Pure Confidence

Steady and ready—with the ability to maintain durability during slow-load activities—are just some of the many benefits of **RUSH ROGUE® 2**. Remarkably reliable, this premier, fiberglass vertical shock foot from PROTEOR delivers increased dorsiflexion strength and the utmost flexibility.

- **Walk More Easily and Naturally:** Ideal dynamics design with a Heel Shock Bumper for maximum energy return at heel strike.
- **Move More Ways:** Provides optimal durability to perform the way users want it to.
- **Seamless Movement:** Axial rotation of +/- 15° reduces socket pressure and allows for quick pivoting.
- **Go More Places:** Now available in sandal toe.
- **Waterproof** (fresh or saltwater)



L5987 & L5984

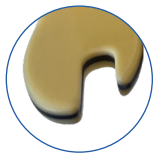

**NOW AVAILABLE!**  
Sandal Toe  
Sizes 22-29cm

### TECHNICAL FEATURES

Item N°	ROG2
Weight (26 Cat 4, with foot shell and spectra sock)	1039g / 2.3lbs
Build Height*	22 - 24cm
	25 - 27cm
	28 - 29cm
Heel Height	3/8" / 10mm
Standard Foot Shell (With CAP)	FS
Sandal Toe Foot Shell (No CAP)	FTC-2R-1

Black Spectra Sock and Heel Wedge included in each Foot Module delivery.  
Foot Shell must be ordered separately.

\*Build height based on size 23cm, 26cm, or 29cm Cat 4 foot module with spectra sock, foot shell and 10mm heel height.

### \*THE ORIGINAL RUSH ROGUE IS NO LONGER AVAILABLE\*

Weight/ Activity level	Module selection according to activity and weight								
	0-105lbs 0-48kg	106-140lbs 49-64kg	141-175lbs 65-79kg	176-210lbs 80-95kg	211-245lbs 96-111kg	246-280lbs 112-127kg	281-315lbs 128-143kg	316-350lbs 144-159kg	351-365lbs 160-166kg
Low	1	2	3	4	5	6	7	8	9
Moderate	1	2	3	4	5	6	7	8	9
High	2	3	4	5	6	7	8	9	-

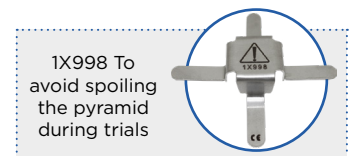

NOTE: Increasing category numbers indicate increased keel response. FOR BILATERAL PATIENTS: Increase by one category for added stability.

[DOWNLOAD PRODUCT SHEET](#)

[CONTACT US](#)
[ORDER](#)



1236 West Southern Avenue #101, Tempe, AZ 85282 • 855.450.7300

shop.proteorusa.com #HumanFirst

#HUMANFIRST

## Virtually Indestructible

The **RUSH HiPro**® provides a realistic and responsive foot with smooth rollover. Made from an advanced engineered glass composite, wearers can feel confident in its durability with the added flexibility. The energy return of this foot enables amputees to easily traverse the most aggressive terrain while experiencing zero dead spots.

- Highly dynamic
- High energy return
- Smooth roll over
- All-terrain and waterproof (fresh or saltwater)



L5981

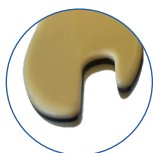

**NOW AVAILABLE!**  
Sandal Toe  
Sizes 22-29cm

### TECHNICAL FEATURES

Item N°.		HiP
Weight	(26 Cat 4, with foot shell and spectra sock)	920g / 2.0lbs
Build Height*	22 - 24cm	6.5" / 165mm
	25 - 27cm	6.9" / 175mm
	28 - 29cm	7.1" / 181mm
Heel Height		3/8" / 10mm
Standard Foot Shell (With CAP)		FS
Sandal Toe Foot Shell (No CAP)		FTC-2R-1

Black Spectra Sock and Heel Wedge included in each Foot Module delivery.

Foot Shell must be ordered separately.

\*Build height based on size 23cm, 26cm, or 29cm Cat 4 foot module with spectra sock, foot shell and 10mm heel height.

Module selection according to activity and weight									
Weight/Activity level	0-105lbs 0-48kg	106-140lbs 49-64kg	141-175lbs 65-79kg	176-210lbs 80-95kg	211-245lbs 96-111kg	246-280lbs 112-127kg	281-315lbs 128-143kg	316-350lbs 144-159kg	351-365lbs 160-166kg
Low	1	2	3	4	5	6	7	8	9
Moderate	1	2	3	4	5	6	7	8	9
High	2	3	4	5	6	7	8	9	-

1X998 To avoid spoiling the pyramid during trials



NOTE: Increasing category numbers indicate increased keel response. FOR BILATERAL PATIENTS: Increase by one category for added stability.

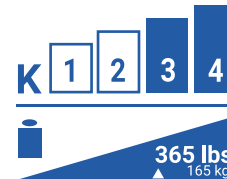

FEET

## Extraordinary Adventures Begin with the ROVER

With a build height of just over two inches, even the most extremely limited clearance patients will benefit from the dynamic toe-off and superior energy return of the **RUSH ROVER®**. Capable. Strong. Comfortable. From rocky trailheads to the sidewalks of a concrete jungle, navigate even the most demanding terrain with ease. With the **RUSH ROVER**...the world is yours.



L5981



- Smooth roll through
- Dynamic toe-off
- Most durable low-profile foot available

### TECHNICAL FEATURES

Item N°.		ROV
Weight	(26 Cat 4, with foot shell and spectra sock)	950g / 2.1lbs
Build Height*	22 - 24cm	2.1" / 54mm
	25 - 27cm	2.3" / 60mm
	28 - 30cm	2.5" / 64mm
Heel Height		3/8" / 10mm
Standard Foot Shell (No CAP)		FSK

Black Spectra Sock and Heel Wedge included in each Foot Module delivery.  
Foot Shell must be ordered separately.

\*Build height based on size 23cm, 26cm, or 29cm Cat 4 foot module with spectra sock, foot shell and 10mm heel height.

Module selection according to activity and weight									
Weight/ Activity level	0-105lbs 0-48kg	106-140lbs 49-64kg	141-175lbs 65-79kg	176-210lbs 80-95kg	211-245lbs 96-111kg	246-280lbs 112-127kg	281-315lbs 128-143kg	316-350lbs 144-159kg	351-365lbs 160-166kg
Low	1	2	3	4	5	6	7	8	9
Moderate	1	2	3	4	5	6	7	8	9
High	2	3	4	5	6	7	8	9	-

1X998 To avoid spoiling the pyramid during trials



NOTE: Increasing category numbers indicate increased keel response. FOR BILATERAL PATIENTS: Increase by one category for added stability.

DOWNLOAD PRODUCT SHEET



CONTACT US

ORDER



1236 West Southern Avenue #101, Tempe, AZ 85282 • 855.450.7300

shop.proteorusa.com #HumanFirst

#HUMANFIRST



# HIGHLANDER® HIGHLANDER® MAX

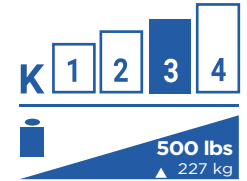

FEET

Now Available in  
**EVAQ8®**



L5981

\*Highlander MAX is not PDAC Verified.

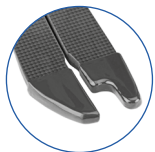

Sandal-toe available for sizes 22-28cm.

## Time Tested Stability and Dynamics

The **Highlander®** prosthetic foot provides active patients with long residual limbs an efficient and smooth gait, with excellent energy return. A split heel and keel provides excellent inversion-eversion, allowing users to walk and run with confidence on uneven terrain. The **Highlander MAX** can be ordered to accommodate users up to 500lbs.\*\* As a result, amputees once limited to lower functioning products can now enjoy the benefits provided by a premium energy storage and return device so they can walk farther, faster, longer.

- Water resistant
- Engineered for active amputees with long residual limbs
- Split keel and heel provides excellent inversion-eversion
- Offers ideal blend of stability and action, often preferred by transfemoral amputees
- Can be designed for amputees weighing up to 500lbs with the **Highlander MAX** option

### TECHNICAL FEATURES

Item N°.	FS3-00	FS3-H5
Weight (26 Cat 4, module with foot shell and spectra sock)	538g / 1.9lbs	
Build Height*	22 - 25cm	3.8" / 97mm
	26 - 28cm	4.3" / 110mm
	29 - 31cm	4.6" / 118mm
Heel Height	3/8" / 10mm	
Standard Foot Shell (No CAP)	FTC-3M-1	
Standard Foot Shell (With CAP)	FTC-3M-0	
Sandal Toe Foot Shell (No CAP)	FTC-2M-1	

Black Spectra Sock and Heel Bumper Kit included in each Foot Module delivery.

Foot Shell must be ordered separately.

1X998 To avoid spoiling the pyramid during trials



\*Build height based on size 23cm, 26cm, 29cm Cat 4 foot module with foot shell, spectra sock, and 10mm heel height. Sandal-toe available for sizes 22-28cm.

### Module selection according to activity and weight

Weight/Activity level	100-115lbs 44-52kg	116-130lbs 53-59kg	131-150lbs 60-68kg	151-170lbs 69-77kg	171-195lbs 78-88kg	196-220lbs 89-100kg	221-255lbs 101-116kg	256-285lbs 117-130kg	286-325lbs 131-147kg	326-365lbs 148-166kg	366-420lbs 167-190kg	421-480lbs 191-218kg	481-500lbs 219-227kg
Low	1	1	2	3	4	5	6	7	8	9	10**	11**	12**
Moderate	1	2	3	4	5	6	7	8	9	10**	-	-	-
High	2	3	4	5	6	7	8	9	10**	11**	-	-	-

\*\*Highlander MAX Custom order only



CONTACT US

ORDER



1236 West Southern Avenue #101, Tempe, AZ 85282 • 855.450.7300

shop.proteorusa.com #HumanFirst

#HUMANFIRST



# RUSH Chopart

K 1 2 3 4

365 lbs  
165 kg

FEET

## Virtually Indestructible

The **RUSH Chopart** is specifically designed for people with Chopart amputations as well as Lisfranc, Pirogoff, Boyd and partial foot prostheses. A dynamic design, providing increased reliability and eliminating the breakage commonly seen with carbon Chopart plates. The unique glass composite is engineered to be more flexible and durable than any other Chopart available today.

- Highly dynamic
- Durable
- Smooth roll over
- Waterproof (fresh or salt water)



L5976



### TECHNICAL FEATURES

Item N°.		CHO
Weight	(26 Cat 4, with foot shell and spectra sock)	380g / 0.8lbs
Build Height*	19 - 21cm	0.84" / 21mm
	22 - 24cm	1" / 25mm
	25 - 27cm	1.1" / 29mm
	28 - 30cm	0.8" / 22mm
Heel Height		3/8" / 10mm
Standard Foot Shell, 19-21 cm (No CAP)		FSK
Standard Foot Shell, 22-30cm (With CAP)		FS

Black Spectra Sock and Heel Wedge included in each Foot Module delivery. Foot Shell must be ordered separately.

\*Build height based on size 23cm, 26cm, or 29cm Cat 4 foot module with spectra sock, foot shell and 10mm heel height.

Module selection according to activity and weight for sizes 19-21cm									
Peds	Weight/ Activity level	0-30lbs 0-14kg	31-45lbs 15-20kg	46-60lbs 21-27kg	61-75lbs 28-34kg	76-90lbs 35-41kg	91-105lbs 42-48kg	106-120lbs 49-54kg	121-135lbs. 55-61kg
	Low	1P	2P	3P	4P	5P	6P	7P	8P
	Moderate	1P	2P	3P	4P	5P	6P	7P	8P
	High	2P	3P	4P	5P	6P	7P	8P	9P

NOTE: Increasing category numbers indicate increased keel response. FOR BILATERAL PATIENTS: Increase by one category for added stability.

Module selection according to activity and weight for sizes 22-30cm									
Weight/ Activity level	0-105lbs 0-48kg	106-140lbs 49-64kg	141-175lbs 65-79kg	176-210lbs 80-95kg	211-245lbs 96-111kg	246-280lbs 112-127kg	281-315lbs 128-143kg	316-350lbs 144-159kg	351-365lbs 160-166kg
Low	1	2	3	4	5	6	7	8	9
Moderate	1	2	3	4	5	6	7	8	9
High	2	3	4	5	6	7	8	9	-

NOTE: Increasing category numbers indicate increased keel response. FOR BILATERAL PATIENTS: Increase by one category for added stability.

DOWNLOAD PRODUCT SHEET



CONTACT US

ORDER



1236 West Southern Avenue #101, Tempe, AZ 85282 • 855.450.7300

shop.proteorusa.com #HumanFirst

#HUMANFIRST



# AGILIX

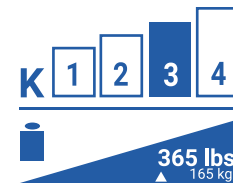

FEET

Now Available in  
**EVAQ8®**

## Maximum Shock Value

The **Agilix** is a multi-axial, shock absorbing, flexible foot system designed to manage loading impacts, reduce socket shear forces, and improve comfort while walking on any terrain. The ultra-lightweight design offers K3 ambulators the most exciting and comfortable daily experience.

- Water resistant
- Vertical shock absorption and carbon fiber flexibility optimized for low to moderate impact
- K3 ambulators
- Multi-axial function increases ground compliance and stability
- Streamlined, split keel and heel design results in improved long-term durability
- Full length dynamic heel attached at the toe ensures a seamless rollover, for superior comfort and a more symmetrical gait
- Lower profile and lighter weight than the competitive alternative, allowing users to do more and feel less tired at the end of the day

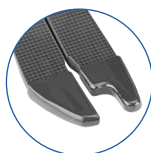

Sandal-toe available for sizes 22-28cm.

### TECHNICAL FEATURES

Item N°.	F15
Weight (26 Cat 4, module with foot shell and spectra sock)	605g / 1.3lbs
Build Height*	22 - 25cm
	26 - 28cm
	29 - 31cm
Heel Height	3/8" / 10mm
Standard Foot Shell (No CAP)	FTC-3M-1
Standard Foot Shell (With CAP)	FTC-3M-0
Sandal Toe Foot Shell (No CAP)	FTC-2M-1

Black Spectra Sock and Heel Bumper Kit included in each Foot Module delivery.  
Foot Shell must be ordered separately.

\*Build height based on size 23cm, 26cm, 29cm Cat 4 foot module with foot shell, spectra sock, and 10mm heel height. Sandal-toe available for sizes 22-28cm.

Module selection according to activity and weight										
Weight/Activity level	100-115lbs 44-52kg	116-130lbs 53-59kg	131-150lbs 60-68kg	151-170lbs 69-77kg	171-195lbs 78-88kg	196-220lbs 89-100kg	221-255lbs 101-116kg	256-285lbs 117-130kg	286-325lbs 131-147kg	326-365lbs 148-166kg
Low	1	1	2	3	4	5	6	7	8	9
Moderate	1	2	3	4	5	6	7	8	9	-

1X998 To avoid spoiling the pyramid during trials



CONTACT US

ORDER



1236 West Southern Avenue #101, Tempe, AZ 85282 • 855.450.7300

shop.proteorusa.com #HumanFirst

#HUMANFIRST

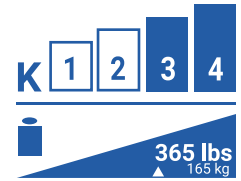

FEET

## Unbridled Capabilities

Introducing the **RUSH RAMPAGE®**. With the smooth roll-through, increased comfort, and all-terrain capability of its predecessors, this foot boasts a more cosmesis-friendly option, with a lower overall product weight. The **RUSH RAMPAGE** is the perfect solution for individuals seeking a blend of both cosmetic and high-performance capabilities experienced in the RUSH Foot Collection. Are you ready to RAMPAGE?

- Cosmesis-ready to meet your aesthetic preferences
- Lower overall product weight
- Smooth roll-through with unparalleled energy return
- Extreme reliability for any use in any environment
- Waterproof (fresh and saltwater)

### TECHNICAL FEATURES

Item N°.		RAM
Weight (26 Cat 4, with foot shell and spectra sock)		850g / 1.9lbs
Build Height*	22 - 24cm	6.6" / 168mm
	25 - 27cm	7.1" / 181mm
	28 - 29cm	7.2" / 184mm
Heel Height		3/8" / 10mm
Standard Foot Shell (With CAP)		FS
Sandal Toe Foot Shell (No CAP)		FTC-2R-1

Black Spectra Sock and Heel Bumper Kit included in each Foot Module delivery.  
Foot Shell must be ordered separately.

\*Build height based on size 23cm, 26cm, or 29cm Cat 4 foot module with spectra sock, foot shell and 10mm heel height.

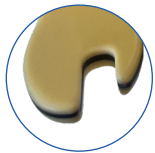

**NOW AVAILABLE!**  
Sandal Toe  
Sizes 22-29cm

Module selection according to activity and weight									
Weight/Activity level	0-105lbs 0-48kg	106-140lbs 49-64kg	141-175lbs 65-79kg	176-210lbs 80-95kg	211-245lbs 96-111kg	246-280lbs 112-127kg	281-315lbs 128-143kg	316-350lbs 144-159kg	351-365lbs 160-166kg
Low	1	2	3	4	5	6	7	8	9
Moderate	1	2	3	4	5	6	7	8	9
High	2	3	4	5	6	7	8	9	-

NOTE: Increasing category numbers indicate increased keel response. FOR BILATERAL PATIENTS: Increase by one category for added stability.

1X998 To avoid spoiling the pyramid during trials



DOWNLOAD PRODUCT SHEET



CONTACT US

ORDER



1236 West Southern Avenue #101, Tempe, AZ 85282 • 855.450.7300

shop.proteorusa.com #HumanFirst

#HUMANFIRST



FEET

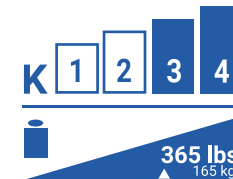

## Innovation You Can Feel

Thanks to the unique sole plate and virtually indestructible glass composite, the **RUSH RAMPAGE® LP** delivers a smooth transition from heel strike to toe-off. Patients will experience unparalleled comfort, range of motion, and zero dead spots in every step.

- Low-profile build
- Superior ground compliance
- Smooth rollover
- High-energy return
- Cosmesis-friendly
- All-terrain
- Waterproof (fresh or salt water)

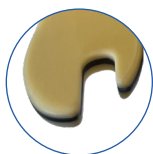

**NOW AVAILABLE!**  
Sandal Toe  
Sizes 22-29cm

### TECHNICAL FEATURES

Item N°.		RAMLP
Weight (26 Cat 4, with foot shell and spectra sock)		805g
Build Height*	22 - 24cm	4.5" / 114mm
	25 - 27cm	4.7" / 121mm
	28 - 29cm	4.7" / 121mm
Heel Height		3/8" / 10mm
Standard Foot Shell (With CAP)		FS
Sandal Toe Foot Shell (No CAP)		FTC-2R-1

Black Spectra Sock and Heel Wedge included in each Foot Module delivery.

Foot Shell must be ordered separately.

\*Build height based on size 23cm, 26cm, or 29cm Cat 4 foot module with spectra sock, foot shell and 10mm heel height.

Module selection according to activity and weight									
Weight/ Activity level	0-105lbs 0-48kg	106-140lbs 49-64kg	141-175lbs 65-79kg	176-210lbs 80-95kg	211-245lbs 96-111kg	246-280lbs 112-127kg	281-315lbs 128-143kg	316-350lbs 144-159kg	351-365lbs 160-166kg
Low	1	2	3	4	5	6	7	8	9
Moderate	2	3	4	5	6	7	8	9	-
High	3	4	5	6	7	8	9	9	-

1X998 To avoid spoiling the pyramid during trials



NOTE: Increasing category numbers indicate increased keel response. FOR BILATERAL PATIENTS: Increase by one category for added stability.

DOWNLOAD PRODUCT SHEET



CONTACT US

ORDER



1236 West Southern Avenue #101, Tempe, AZ 85282 • 855.450.7300

shop.proteorusa.com #HumanFirst

#HUMANFIRST





# SIERRA®

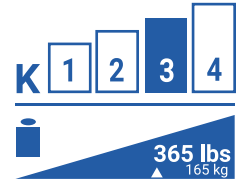

FEET

Now Available in  
**EVAQ8®**

## Ultimate Flexibility for a Smoother Gait

The **Sierra®** prosthetic foot incorporates a long carbon fiber spring to provide users a smooth gait over a broad spectrum of activities. The split keel and heel design provides excellent inversion-eversion so that patients can walk with confidence on uneven terrain. A full-length heel enables foot flat early in the gait cycle, providing a compliant foot with a stable base of support. The result is a product that allows amputees to walk comfortably with confidence.

- Water-resistant
- Angle-top design increases the length of the carbon fiber spring, providing a smoother gait and ultimate flexibility

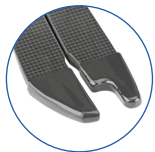

Sandal-toe available for sizes 22-28cm.

### TECHNICAL FEATURES

Item N°.		FS1
Weight (26 Cat 4, module with foot shell and spectra sock)		597g / 1.3lbs
Build Height*	22 - 25cm	5.3" / 135mm
	26 - 28cm	6.2" / 158mm
	29 - 31cm	6.7" / 172mm
Heel Height		3/8" / 10mm
Standard Foot Shell (No CAP)		FTC-3M-1
Standard Foot Shell (With CAP)		FTC-3M-0
Sandal Toe Foot Shell (No CAP)		FTC-2M-1

Black Spectra Sock and Heel Bumper Kit included in each Foot Module delivery.

Foot Shell must be ordered separately.

\*Build height based on size 23cm, 26cm, 29cm Cat 4 foot module with foot shell, spectra sock, and 10mm heel height. Sandal-toe available for sizes 22-28cm.

Weight/ Activity level	Module selection according to activity and weight									
	100-115lbs 44-52kg	116-130lbs 53-59kg	131-150lbs 60-68kg	151-170lbs 69-77kg	171-195lbs 78-88kg	196-220lbs 89-100kg	221-255lbs 101-116kg	256-285lbs 117-130kg	286-325lbs 131-147kg	326-365lbs 148-166kg
Low	1	1	2	3	4	5	6	7	8	9
Moderate	1	2	3	4	5	6	7	8	9	-
High	2	3	4	5	6	7	8	9	-	-

1X998 To avoid spoiling the pyramid during trials

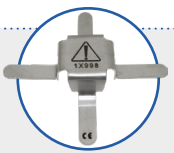

CONTACT US

ORDER



1236 West Southern Avenue #101, Tempe, AZ 85282 • 855.450.7300

shop.proteorusa.com #HumanFirst

#HUMANFIRST



# PACIFICA PACIFICA LP

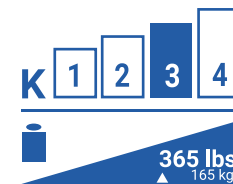

## Because Height Matters

The **Pacifica**® prosthetic foot is ideal for users with long residual limbs, due to its low profile design. In contrast with competing low profile foot products, which may feel stiff and uncomfortable, **Pacifica** users experience flexibility and energy return allowing them to walk further, faster, and longer. The lightweight and durable design requires less energy expenditure so that amputees are comfortable on their feet for longer periods of time. The pyramid lies within the foot shell, simplifying the cosmetic finishing process. A low build height also provides room for additional componentry, such as a rotator or shock absorber which can provide added comfort.

- Water-resistant
- Choose between the **Pacifica (FS2)** and **Pacifica LP (FS4)**, each perfect for with long residual limbs or those needing more clearance
- LP design requires as little as 2" of clearance
- Lightweight and durable

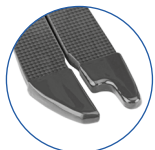

Sandal-toe available for sizes 22-28cm.

### TECHNICAL FEATURES

Item N°.	FS2: Pacifica® (sizes: 24 - 31cm)	FS4: Pacifica® LP (sizes: 22 - 31cm)
Weight (26 Cat 4, module with foot shell and spectra sock)	545g / 1.2lbs	537g / 1.1lbs
Build Height*	22 - 25cm	2.5" / 65mm
	26 - 28cm	2.6" / 66mm
	29 - 31cm	2.7" / 70mm
Heel Height	3/8" / 10mm	3/8" / 10mm
Standard Foot Shell (No CAP)		FTC-3M-1
Standard Foot Shell (With CAP)		FTC-3M-0
Sandal Toe Foot Shell (No CAP)		FTC-2M-1

Black Spectra Sock and Heel Bumper Kit included in each Foot Module delivery.  
Foot Shell must be ordered separately.

\*Build height based on size 23cm, 26cm, 29cm Cat 4 foot module with foot shell, spectra sock, and 10mm heel height. Sandal-toe available for sizes 22-28cm.

Module selection according to activity and weight										
Weight/Activity level	100-115lbs 44-52kg	116-130lbs 53-59kg	131-150lbs 60-68kg	151-170lbs 69-77kg	171-195lbs 78-88kg	196-220lbs 89-100kg	221-255lbs 101-116kg	256-285lbs 117-130kg	286-325lbs 131-147kg	326-365lbs 148-166kg
Low	1	1	2	3	4	5	6	7	8	9
Moderate	1	2	3	4	5	6	7	8	9	-
High	2	3	4	5	6	7	8	9	-	-

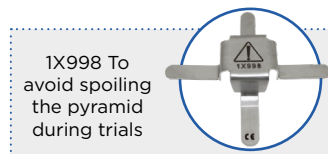



FEET

# DYNADAPT

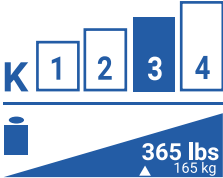

Now Available in  
**EVAQ8®**

## Fit, Finish, and Roll

The **DynAdapt** prosthetic foot is a slim profile carbon fiber foot system with a slender, anatomic design for easy fit and finish. Its multi-axial function provides maximum comfort and the uninterrupted strands of carbon fiber in the full-length keel and patients with effortless rollover and a more natural gait.

- Water-resistant
- A full length, unbolted sole plate ensures seamless stance phase roll-over for superior comfort
- Split keel and heel design increase ground compliance and improve stability

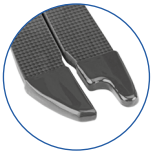

Sandal-toe available for sizes 22-28cm.

### TECHNICAL FEATURES

Item N°.		F10
Weight (26 Cat 4, module with foot shell and spectra sock)		628g / 1.4lbs
Build Height*	22 - 25cm	6.1" / 155mm
	26 - 28cm	6.5" / 166mm
	29 - 31cm	7" / 178mm
Heel Height		3/8" / 10mm
Standard Foot Shell (No CAP)		FTC-3M-1
Standard Foot Shell (With CAP)		FTC-3M-0
Sandal Toe Foot Shell (No CAP)		FTC-2M-1

Black Spectra Sock and Heel Bumper Kit included in each Foot Module delivery.  
  
Foot Shell must be ordered separately.

\*Build height based on size 23cm, 26cm, 29cm Cat 4 foot module with foot shell, spectra sock, and 10mm heel height. Sandal-toe available for sizes 22-28cm.

Module selection according to activity and weight										
Weight/ Activity level	100-115lbs 44-52kg	116-130lbs 53-59kg	131-150lbs 60-68kg	151-170lbs 69-77kg	171-195lbs 78-88kg	196-220lbs 89-100kg	221-255lbs 101-116kg	256-285lbs 117-130kg	286-325lbs 131-147kg	326-365lbs 148-166kg
Low	1	1	2	3	4	5	6	7	8	9
Moderate	1	2	3	4	5	6	7	8	9	-
High	2	3	4	5	6	7	8	9	-	-



CONTACT US

ORDER



1236 West Southern Avenue #101, Tempe, AZ 85282 • 855.450.7300

shop.proteorusa.com #HumanFirst

#HUMANFIRST

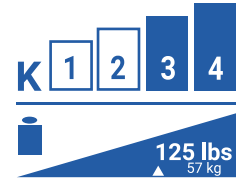

FEET

## Meet the New Kid on the Block

Built kid tough, the **RUSH Kid**® pediatric foot can handle even the most extreme low or high clearance patient. Run, jump, play...the ultra low profile build delivers the most dynamic energy return and smooth roll-through of any pediatric foot on the market today. Mud, water, sand....no problem! The all-terrain **RUSH Kid** was built with active kids in mind. Say goodbye to broken carbon feet!

- Smooth Rollover
- Dynamic Toe-Off
- Most Durable Low-Profile Foot Available



### TECHNICAL FEATURES

Peds	Item N°.	KID
	Weight (20 Cat 4, with foot shell and spectra sock)	505g
	Build Height*	2" / 51mm
	Size	19 - 21cm
	Heel Height	3/8" / 10mm
	Standard Foot Shell (No CAP)	FSK

Black Spectra Sock and Heel Wedge included in each Foot Module delivery. Foot Shell must be ordered separately.

\*Build height includes spectra sock, foot shell and 10mm heel height.

Module selection according to activity and weight									
Weight/Activity level	0-30lbs 0-14kg	31-45lbs 15-20kg	46-60lbs 21-27kg	61-75lbs 28-34kg	76-90lbs 35-41kg	91-105lbs 42-48kg	106-120lbs 49-54kg	121-135lbs 55-61kg	
Low	1P	2P	3P	4P	5P	6P	7P	8P	
Moderate	1P	2P	3P	4P	5P	6P	7P	8P	
High	2P	3P	4P	5P	6P	7P	8P	9P	

1X998 To avoid spoiling the pyramid during trials



NOTE: Increasing category numbers indicate increased keel response. FOR BILATERAL PATIENTS: Increase by one category for added stability.

DOWNLOAD PRODUCT SHEET



CONTACT US

ORDER



1236 West Southern Avenue #101, Tempe, AZ 85282 • 855.450.7300

shop.proteorusa.com #HumanFirst

#HUMANFIRST

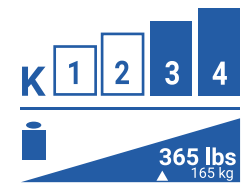

FEET

## Incomparable Grip. No Foot Shell Required.

The **RUSH Foot H2O Collection** is the ideal foot for your shower leg or various, non invasive water sport activities. Available in the tried-and-true RUSH Foot **HiPro**, **RAMPAGE**, **RAMPAGE LP** and **ROGUE 2** models and featuring an integrated Vibram® sole and custom molded rubber toe wrap. The **RUSH Foot H2O Collection** of feet offers the same great durability and comfort of all the other RUSH feet, but now adds superior traction on slick surfaces. From the shower to the pool, you won't find a foot that provides this amount of grip and added confidence on slippery surfaces.



L5987 & L5984  
(ROGUE 2)

- Showering
- Surfing
- Stand Up Paddleboard
- Indoor Yoga
- Gymnastics
- Pool Activities
- Kayaking
- Boarding
- Karate
- Barefoot Activities
- Water proof (fresh and saltwater)

### TECHNICAL FEATURES

Item N°.	HiPro: H2H	RAMPAGE LP: H2RAMLP	ROGUE 2: H2R2	RAMPAGE: H2RAM
Weight (26 Cat 4, module only)	765g / 1.7lbs	650g / 1.4lbs	883g / 1.9lbs	695g / 1.5lbs
Build Height*	22 - 24	6" / 152mm	4.1" / 105mm	5.6" / 142mm
	25 - 27	6.2" / 159mm	4.1" / 105mm	6" / 152mm
	28 - 29	6.8" / 175mm	4.3" / 111mm	6.5" / 165mm
				7" / 178mm

\*Build height based on size 23cm, 26cm, or 29cm Cat 4 foot module only.

Black Spectra Sock and Heel Wedge included in each Foot Module delivery.  
Foot Shell must be ordered separately.



DOWNLOAD PRODUCT SHEET



CONTACT US

ORDER



1236 West Southern Avenue #101, Tempe, AZ 85282 • 855.450.7300

shop.proteorusa.com #HumanFirst

#HUMANFIRST



# RUSH FOOT® EVAQ8 COLLECTION

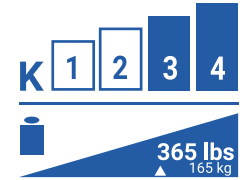

FEET

## Simplistic, Effective, Efficient

Finally, a vacuum system that seamlessly integrates effective vacuum with the same rugged simplicity of all the RUSH Foot designs. The **RUSH EVAQ8® Collection** is the easy solution to providing maximum vacuum efficiency in just a few quick steps. No batteries or complicated-mechanical pump required.

- Simple, integrated design
- Stabilizes volume, increases linkage, and heightens proprioception through elevated vacuum suspension
- All-terrain, fully submersable
- Requires minimal maintenance
- The **RUSH EVAQ8 Collection** is available in the **RAMPAGE, HiPro, ROGUE 2, and RAMPAGE LP** models
- All models now available in sandal toe



L5987 & L5984  
(ROGUE 2)

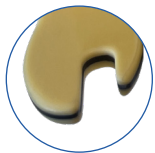

**NOW AVAILABLE!**

Sandal Toe for  
All EVAQ8 Feet  
Sizes 22-29cm

### TECHNICAL FEATURES

Item N°.	RAMPAGE: EVRAM	HiPro: EVQH	RAMPAGE LP: EVGRAMLP	ROGUE 2: EVQR2	
Weight (26 Cat 4, with foot shell and spectra sock)	860g	930g	815g	1048g	
Build Height*	22 - 24cm	6.6" / 168mm	6.5" / 165mm	4.5" / 114mm	6.1" / 155mm
	25 - 27cm	7.1" / 181mm	6.8" / 175mm	4.7" / 121mm	6.6" / 168mm
	28 - 29cm	7.2" / 184mm	7.1" / 181mm	4.7" / 121mm	6.7" / 171mm
Heel Height	3/8" / 10mm				

See Foot Module Pages for Foot Shell Information

\*Build height based on size 23cm, 26cm, or 29cm Cat 4 foot module with spectra sock, foot shell and 10mm heel height.

Black Spectra Sock and Heel Wedge included in each Foot Module delivery. Foot Shell must be ordered separately.



### REBUILD KIT #EVRB

- 90 Degree Hose Barb
- 2' Tygon Vacuum Hose
- Hose Barb Filter
- 1/2" Wide Hook and Loop

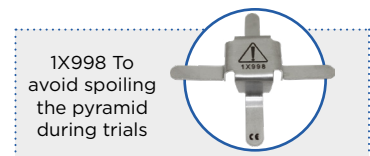

DOWNLOAD PRODUCT SHEET



CONTACT US

ORDER



1236 West Southern Avenue #101, Tempe, AZ 85282 • 855.450.7300

shop.proteorusa.com #HumanFirst

#HUMANFIRST



# EVAQ8®

FEET

## EVAQ8® - The Collection has Expanded!

Meeting the need for innovation, versatility, and pure satisfaction, the popular **EVAQ8** vacuum system collection by PROTEOR is expanding beyond our legacy RUSH feet to carbon fiber and EnduraCore® feet.

- Optimal design – No additional build height and very low added weight (40G)
- High durability – Rubber vacuum chamber is designed to last – even with continued use over time
- Responds automatically – Pulls vacuum as needed with every step
- The **EVAQ8® Collection** now available in **SHOCKWAVE, AGILIX, SIERRA, HIGHLANDER, DYNADAPT, and KINTERRA**



### TECHNICAL FEATURES

Item N°.	SHOCKWAVE: F20-V2	AGILIX: F15-V2	SIERRA: FS1-V2	HIGHLANDER: FS3-V2	DYNADAPT: F10-V2	KINTERRA: RM3-V2
Weight (26 Cat 4, with foot shell and spectra sock)	1018g	645g	637g	578g	668g	873g
Build Height*	22-25cm**	6.9" / 176mm	5.5" / 140mm	5.3" / 135mm	3.8" / 95mm	6.1" / 155mm
	26-28cm	7.4" / 189mm	6.2" / 159mm	6.2" / 158mm	4.3" / 110mm	6.5" / 166mm
	29-31cm***	7.8" / 200mm	6.8" / 173mm	6.7" / 172mm	4.6" / 118mm	7.0" / 178mm

See Foot Module Pages for Foot Shell Information

Black Spectra Sock and Heel Wedge included in each Foot Module delivery.  
Foot Shell must be ordered separately.

\*Build height based on size 23cm, 26cm, or 29cm Cat 4 foot module with spectra sock, foot shell, and 10mm heel height.

\*\*SHOCKWAVE = 23-25cm

\*\*\*SHOCKWAVE = 29-30cm



DOWNLOAD PRODUCT SHEET



CONTACT US

ORDER



1236 West Southern Avenue #101, Tempe, AZ 85282 • 855.450.7300

shop.proteorusa.com #HumanFirst

#HUMANFIRST

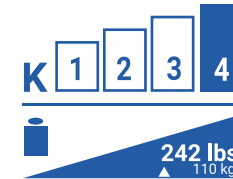

FEET

## In the gym, at the park, or on the trail... the EasyRun blade by PROTEOR is the perfect foot to get you moving.

So, you're not an experienced sprinter? Not to worry! Whether you're exploring new activities or looking to take your daily workout to a new level, the **EasyRun** will help you increase strength, mobility, happiness, and amplify your life. With its all-terrain, all-weather, curved fiberglass blade design, and anti-slip Vibram® sole you can take your **EasyRun** workout outside with confidence.

- Rotatable pyramid adapter
- Curved fiber glass blade
- Anti-slip sole.
- 6 vibrant designs



USA



Orange Black Water Tag Purple

### TECHNICAL FEATURES

Weight	2.40lbs / 1088g
Build Height	8.6in / 220mm
Materials	Fiberglass + rubber
Connection	Rotatable Pyramid

Design	Orange	Black	Water	Tag	Purple	USA
Item N°	1A920-...O	1A920-...N	1A920-...E	1A920-...G	1A920-...V	1A920-...U

... = Module

Green sole kit	1A92013-1
Black sole kit	1A92013-2

Module selection according to activity and weight							
Activity/Weight	88-108lbs 40-49kg	110-130lbs 50-59kg	132-152lbs 60-69kg	154-174lbs 70-79kg	176-194lbs 80-88kg	198-218lbs 90-99kg	220-242lbs 100-110kg
Moderate Impact		1	2	3	4	5	6
High Impact	1	2	3	4	5	6	

1X998 To avoid spoiling the pyramid during trials



DOWNLOAD PRODUCT SHEET



CONTACT US

ORDER



1236 West Southern Avenue #101, Tempe, AZ 85282 • 855.450.7300

shop.proteorusa.com #HumanFirst

#HUMANFIRST





FEET

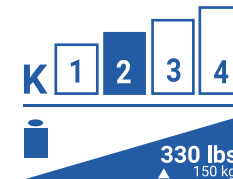

## Comfort and Freedom

The **Gery** foot aims to provide lower level K1-K2 users with the freedom they deserve. It greatly assists your patient's ability to ambulate with its lightweight design and accommodates heel heights ranging from .2" to .8" (5mm to 20mm). The **Gery** is easily cleaned with water and resistant to dirt thanks to its closed cell EVA foam.

- Engineered specifically for the low-level K2 ambulators
- Appropriate for both transtibial or transfemoral amputations
- Not recommended for persons with bilateral amputations
- Lightweight thanks to its EVA structure ≈ 30% lighter than a SACH foot!
- 1 Year warranty



### TECHNICAL FEATURES

Weight	395g / 0.9lbs
Build Height	3.2" / 82mm
Heel Height (T)	from .2" to .8" (5mm to 20mm)
Connection	Pyramid
Maximum patient weight	330lbs / 150kg
Activity level	K2

Item N°.	Side	Size	Color
1A200-G...H	G = Left	22 to 29cm	Light
1A200-D...H	D = Right		
1A200-G...BH	G = Left		Dark
1A200-G...BH	D = Right		

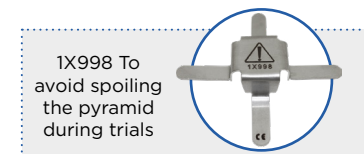

DOWNLOAD PRODUCT SHEET



CONTACT US

ORDER



1236 West Southern Avenue #101, Tempe, AZ 85282 • 855.450.7300

shop.proteorusa.com #HumanFirst

#HUMANFIRST



## Comfort and Dynamics

Aided by the shape of the carbon strut, the **DynaStep** ensures energy savings and comfort while providing the patient with dynamics suitable to a K3 activity level; the split toe design allows inversion and eversion while navigating uneven terrain.

- Appropriate for persons with transtibial and transfemoral amputations
- Foam of the foot is molded on the carbon strut



L5981



### TECHNICAL FEATURES

Item N°.	Side	Size (cm)	Max. Patient Weight
1A101-D...	Right	22 to 25	176lbs / 80kg
1A101-G...	Left	26 to 29	220lbs / 100kg



Ankle Item N°.  
1D111



L5981 & L5986



## DynaStep Foot + Multi-axis Ankle Kit

The combination of a **DynaStep** foot and a 1D111 Multiaxis Ankle allows the patient to perform motions of plantar and dorsiflexion, as well as inversion-eversion. Particularly appropriate for transfemoral.

### TECHNICAL FEATURES

KIT	Composition	Size (cm)
1E201	1A101 + 1D111	22 to 29



# FOOTSHELL & SPECTRA

FEET

## PROTEOR offers a variety of cosmetic foot shells and Spectra® Socks.



Please use the following guide to determine which foot shells and socks are available for each foot product. Not all Foot Modules are available in Sandal Toe; ensure the corresponding Sandal Toe foot module is also ordered (CAPs are not available for sandal toe products).

### STANDARD FOOT SHELLS

(Available for Aglix, DynAdapt, Highlander, Highlander MAX, Pacifica, Pacifica LP, Sierra, and Kinterra foot modules only)

#### Standard Foot Shell, No CAP



(Pacifica only available in 24-31cm)

**FTC-3M-1**  **4-R** 

Size: 22-31cm  
Skin Tone: L=Light, M=Medium, D=Dark  
Side: L=Left, R=Right

#### Standard Foot Shell, with CAP



(Pacifica only available in 24-31cm)

**FTC-3M-0**  **4-R** 

Size: 22-31cm  
Skin Tone: L=Light, M=Medium, D=Dark  
Side: L=Left, R=Right

#### Sandal Toe Foot Shell, No CAP



(Pacifica only available in 24-28cm)

**FTC-2M-1**  **4-R** 

Size: 22-28cm  
Skin Tone: L=Light, M=Medium, D=Dark  
Side: L=Left, R=Right



### KINNEX AND NEW KINTERRA FOOT SHELLS

#### Kinnex Standard Foot Shell, No CAP

**FTC-3K-1**  **4-R** 



Size: 24-30cm  
Skin Tone: L=Light, M=Medium, D=Dark  
Side: L=Left, R=Right

#### Kinnex Sandal Toe Foot Shell, No CAP

**FTC-2K-1**  **4-S** 

Size: 24-28cm  
Skin Tone: L=Light, M=Medium, D=Dark  
Side: L=Left, R=Right



#### New Kinterra Sandal Toe Foot Shell, No CAP

**FTC-2K-1**  **4** 

Size: 22-30cm  
Skin Tone: L=Light, M=Medium, D=Dark  
Toe Configuration: SR=Sandal Toe Right, SL=Sandal Toe Left



### PRO FOOT SHELLS FOR SHOCKWAVE

#### PRO Standard Foot Shell, No CAP

**FTC-3F-1**  **4-R** 

Size: 23-30cm  
Skin Tone: L=Light, M=Medium, D=Dark  
Side: L=Left, R=Right

### PRO Sandal Toe Foot Shell, No CAP



**FTC-2F-1**  **4-S** 

Size: 23-28cm  
Skin Tone: L=Light, M=Medium, D=Dark  
Side: L=Left, R=Right

### RUSH FOOT SHELLS

#### RUSH STANDARD Foot Shell, with CAP



(Available for ROUGE 2, RAMPAGE, RAMPAGE LP, HiPro, Chopart and EVAQ8 foot modules only)

**FS**   

Size: L=Left, R=Right  
Skin Tone: 1=Light, 3=Dark

#### RUSH Sandal Toe Foot Shell, with No CAP



(Available for ROUGE 2, RAMPAGE, RAMPAGE LP, and HiPro including EVAQ8)

**FTC-2R-1**  **4-S** 

Size: 22-29cm  
Skin Tone: L=Light, M=Medium, D=Dark  
Side: L=Left, R=Right

#### RUSH Symes Foot Shell, No Cap

(Available for ROVER, Chopart (19-21) and Kid foot modules only)

**FSK**   

Size: L=Left, R=Right  
Skin Tone: 1=Light, 3=Dark



CONTACT US

ORDER



1236 West Southern Avenue #101, Tempe, AZ 85282 • 855.450.7300

shop.proteorusa.com #HumanFirst

#HUMANFIRST

# FOOTSHELL & SPECTRA

FEET

## Spectra Socks

Description	Item N°.
<b>Black Spectra Sock (1 pk)</b>	
22-25cm foot module = 30cm/12"	SO-NPS-200 <b>XX</b> -00
26-28cm foot module = 35cm/14"	(example: size 26cm foot module = SO-NPS-200 <b>30</b> -00)
29-30cm foot module = 40cm/16"	
<b>Kinnex White Custom Spectra Sock (1 pk)</b>	
Sizes: 24 - 30cm	SO-F14-000 <b>XX</b> -00
	(example: size 26cm foot module = SO-F14-000 <b>26</b> -00)



CONTACT US

ORDER

# DIGITAL

TABLE OF CONTENTS



CONTACT US

ORDER



1236 West Southern Avenue #101, Tempe, AZ 85282 • 855.450.7300

[shop.proteorusa.com](http://shop.proteorusa.com)     #HumanFirst

#HUMANFIRST

# orten

DIGITAL

## A Powerful Solution Made Simple

**Orten** is a full-service O&P CAD/CAM solution powerfully designed to help optimize your workflow and simplify your transition into digital modification.

### Acquisition



- Full access to a powerful software suite designed to support you from start to finish
- Customized tools designed to simplify your workflow
- Immediate ROI via no licensing fees and volume-based pricing
- Continuous investment in product innovation, positioning you for the future

### Modification



### TECHNICAL FEATURES

Item N°	Number of Exported Files (.stl)*
708004UNIT50	50
708004UNIT100	100
708004UNIT200	200
708004UNIT500	500
708004UNIT1000	1,000
708004UNIT1500	1,500
708004UNIT2500	2,500
708004UNIT4000	4,000
708004UNIT7000	7,000
708004UNIT10000	10,000
708004UNIT30000	30,000

\*Exported files are valid for one year



CONTACT US

ORDER

The **Structure Sensor Pro** and **Structure Mark II** provide another option for your iOS devices if you plan to capture devices larger than 15 inches.

Acquisition



Modification



STRUCTURE **SENSOR PRO**



STRUCTURE **MARK II**

Item N°	Description
8A08	Scanner Structure Sensor Pro (without cable)
<b>Cables for Structure Sensor Pro Scanner</b>	
8A0201	Connect. Cable Structure Sensor Pro iPad Pro 11" (1&2 Gen.) AIR 4
8A0202	Connect. Cable For Structure Sensor Pro
8A0203	Connect. Cable Cable Structure Sensor Pro iPad Pro 12.9" (3 & 4 Gen.)
<b>Brackets for Structure Sensor Pro scanner</b>	
8A0204	Structure Sensor Pro Bracket For iPad 7 - 8 - 9 Gen
8A0205	Structure Sensor Pro Bracket For iPad 5 - 6 Gen & iPad Air
8A0206	Structure Sensor Pro Bracket For iPad Pro 9.7" & iPad Air 2
8A0207	Structure Sensor Pro Bracket For iPad Pro 10.5" & iPad Air 3 Gen
8A0208	Structure Sensor Pro Bracket For iPad Pro 11" 1st Gen
8A0209	Structure Sensor Pro Bracket For iPad Pro 12.9" 1/2/3 Gen
8A0210	Structure Sensor Pro Bracket For iPad Pro 11" 2 Gen & 12.9" 4 Gen Air 4
8A0211	Structure Sensor Pro Bracket For iPad Mini 5
8A0212	Structure Sensor Pro Bracket For iPad Mini 6 iPad Pro 12.9 5 Gen

CONTACT US

ORDER

# COMPONENTS

TABLE OF CONTENTS



KITS



TUBES



ADAPTERS



BRACES



LAMINATION ADAPTERS



CONNECTORS



4-HOLE

CONTACT US



ORDER



# TUBES

## COMPONENTS

### Kits

	Item N°.	Description	Max patient weight	Material	Weight
	TK200	Aluminum 10" modular 3 piece set. Includes 30mm Aluminum pylon with receiver, tube clamp with water resistant fasteners and 4-hole pyramid with through hole	220lbs / 100kg	Aluminum	-
	TK300	Titanium 10" modular 3 piece set. Includes 30mm Aluminum pylon with receiver, tube clamp with water resistant fasteners and 4-hole pyramid with through hole	365lbs / 165kg	Titanium	395g
	KIT-00-20200-00	Heavy Duty Adapter Kit for Freedom Highlander MAX. Includes (2) 34mm tube clamps, (1) 4-ear connector for 34mm system and (1) carbon pylon/ tube	500lbs / 227kg	Titanium and Graphite	744g

CONTACT US

ORDER

# TUBES

## COMPONENTS

### Pylons & Tube Clamps

	Item N°	Description	Max patient weight	Material	Weight	Total Height	Build Height
	1D52	Tube Ø 30mm with Pyramid Receiver	220lbs / 100kg	Aluminum	111g	130mm	63mm
	ACC-00-20203-00	Heavy Duty Ø 34mm - 305mm length Pylon/Tube for Freedom Highlander MAX	500lbs / 227kg	Graphite	269g	305mm	-
	1D52-HD	Tube Ø 34mm with Pyramid Receiver	275lbs / 125kg	Aluminum	121g	130mm	67mm
	1D45	Tube adapter Ø 30mm with Aluminum Pyramid Receiver	220lbs / 100kg	Aluminum	290g	440mm	440mm
	1D46	Tube adapter Ø 30mm with Titanium Pyramid Receiver	220lbs / 100kg	Aluminum + Titanium	280g	440mm	440mm
	1G0120#kit	Aluminum tube Ø 30mm - 200mm length and tube clamp	220lbs / 100kg	Aluminum	195g	217mm	-
	1G01-HD	Aluminum tube Ø 34mm - 420mm length	330lbs / 150kg	Aluminum	235g	420mm	-
	1G07	Aluminum tube Ø 22mm - 300mm length used for pediatric prosthesis	99lbs / 45kg	Aluminum	105g	300mm	-

Peds









CONTACT US

ORDER

# ADAPTERS

## COMPONENTS

### Tube Clamp Adapters

	Item N°	Description	Max patient weight	Material	Weight	Total Height	Build Height
Peds		1D39 Pediatric Tube Clamp Adapter Used with the Ø 22mm tube for child prosthesis	99lbs / 45kg	Aluminum	45g	38mm	12mm
		ACC-00-20201-00 Tube Clamp 34mm used with Highlander MAX	500lbs / 227kg	Titanium			
		1D40 Tube Clamp Adapter Female 4-screw adapter for tightening on Ø 30mm tube	220lbs / 100kg	Titanium	90g	50mm	16mm
		1D41 Tube Clamp Adapter Female 4-screw adapter for tightening on Ø 30mm tube	220lbs / 100kg	Aluminum	100g	47mm	13mm
		1D41-HD Tube Clamp Adapter for Ø 34mm Tube Female 4-screw adapter for tightening on Ø 34mm tube	330lbs / 150kg	Aluminum	120g	55mm	17mm
		1K182 Threaded Pyramid insert M36 x 1.5mm	275lbs / 125kg	Stainless steel	65g	28mm	6mm
		1K183 Threaded Receiver insert M36 x 1.5mm Use with 1K179 or 1S145	330lbs / 150kg	Stainless steel	75g	23mm	14mm
		1K184 Threaded Pyramid For screwing on 1P200-KD, 1P320-KD, 1P321-KD, 1P360-KD, 1P130-KD, 1P180-KD	275lbs / 125kg	Stainless steel	94g	30mm	15mm





CONTACT US

ORDER

# CONNECTORS

## COMPONENTS

### Double Adapters

	Description	Item N°.	Max patient weight	Material	Weight	Total Height	Build Height
	Double Pyramid Receiver. Avoid using a tube in tight spaces	1K207-032-HD	330lbs / 150kg	Aluminum	100g	32mm	32mm
		1K207-045-HD			130g	45mm	45mm
		1K207-060-HD			145g	60mm	60mm
		1K207-075-HD			160g	75mm	75mm
	Double Pyramid Adapter	1K190		Stainless steel	120g	36mm	7mm

CONTACT US

ORDER

# CONNECTORS

## COMPONENTS

### Connectors for PROTEOR Knees

These connectors are necessary for the assembly of PROTEOR knees: 1M01 - 1M01-HD - 1M10 - 1M10-HD - 1M102 - 1M102-HD - 1M102V - 1M102V-HD - 1M112 - 1M113

This specific connection system allows you to select the most appropriate linking piece between the knee and the socket. The simplified shape of the upper part of the knee can receive the proximal linking piece using a M8 screw. The knees listed above must be ordered together with one of the following connectors. All these connectors provide a  $\pm 15^\circ$  socket rotation.

	Item N°	Description	Max patient weight	Material	Weight	Connection	Total Height	Build Height	Knee
	1K160	Pyramid Connector provides the male pyramid connection	220lbs / 100kg	Aluminum + Stainless steel	45g	M8	30mm	7mm	1M01 1M10 1M102 1M102V
	1K160-HD	Pyramid Connector for 125kg knee provides the male pyramid connection	275lbs / 125kg	Aluminum + Stainless steel	90g			8mm	1M01-HD 1M10-HD 1M102-HD 1M102V-HD
	1K163	Pyramid Connector provides the male pyramid connection	220lbs / 100kg	Stainless steel	100g				1M01 1M10 1M102 1M102V
	1K164	Pediatric Pyramid Connector provides the male pyramid connection to the 1M112 knee	99lbs / 45kg	Stainless steel	120g			21mm	9mm
Peds	1K20	This $\varnothing$ 30mm Tube Clamp provides a long and lightweight link between the knee and a short residual limb socket. To be assembled using Adapter 1K14	220lbs / 100kg	Aluminum + Steel	210g	Tube $\varnothing$ 30mm M8	218g	210mm	
	1K30	Aluminum Linking plate is convenient for assembly to the distal end of a transfemoral socket with European 4-hole pattern	220lbs / 100kg	Aluminum	80g	M8	21mm	13mm	

CONTACT US

ORDER



1236 West Southern Avenue #101, Tempe, AZ 85282 • 855.450.7300









shop.proteorusa.com #HumanFirst

#HUMANFIRST

# LAMINATION ADAPTER

## COMPONENTS

### Lamination Adapters

	Item N°.	Description	Max patient weight	Material	Weight	Total Height	Build Height
	1K40	Used for knee disarticulation or long residual limb M8 connection	275lbs / 125kg	Steel	120g	120mm	6.5mm
	ACC-00-20202-00	4-Ear Connector for 34 mm System used with Highlander MAX	500lbs / 227kg	Titanium	141g	39mm	-
	1K173	3-prong anchor with pyramid	275lbs / 125kg	Stainless steel	150g	65mm	12mm
	1K176	3-prong anchor with rotating receiver	275lbs / 125kg	Aluminum + Stainless steel	205g	68mm	25mm
	1K177	3-prong anchor with rotating pyramid	220lbs / 100kg	Stainless steel	225g	76mm	17mm
	1K179	Transfemoral Threaded base 3-Prong Lamination Adapter for knee disarticulation, delivered with a spacer. To use with M36 Threaded knees or Threaded inserts	330lbs / 150kg	Stainless steel	125g	45mm	12mm
	1K202	4-ear Lamination Anchor	275lbs / 125kg	Titanium	55g	32mm	10mm
	1K203	4-ear Lamination Anchor HD Stainless steel, heavy duty	330lbs / 150kg	Stainless steel	85g	32mm	10mm
	1K204	4-ear Offset Lamination Anchor HD Trans tibial adapter with 9mm axial offset of the pyramid	330lbs / 150kg	Stainless steel	113g	32mm	11mm



CONTACT US

ORDER

# 4-HOLE ADAPTER

## COMPONENTS

### 4-Hole Adapters

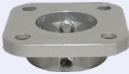
	Item N°.	Description	Max patient weight	Material	Weight	Total Height	Build Height
Peds	 1K206	Pyramid Adapter for Child Socket	99lbs / 45kg	Aluminum + Stainless steel	45g	18mm	6mm
Peds	 1K165	Pyramid Receiver for Child Socket	99lbs / 45kg	Aluminum	35g	13mm	13mm
	 1K172	Stainless Steel Pyramid Receiver for Socket adapter features European 4-hole pattern and a pyramid receiver allowing for tilt adjustment of the socket	275lbs / 125kg	Stainless steel	100g	16mm	16mm
	  1K66	4-hole Receiver Socket adapter features European 4-hole pattern and a pyramid receiver allowing for tilt adjustment of the socket and rotation adjustment	275lbs / 125kg	Titanium	93g	26mm	26mm
	 1K205	4-hole Pyramid Socket adapter features European 4-hole pattern and a pyramid adapter allowing for tilt adjustment of the socket	275lbs / 125kg	Stainless steel	80g	22mm	22mm
	  1K60	4-hole Pyramid Socket adapter features European 4-hole pattern and a pyramid adapter allowing for tilt adjustment of the socket and rotation adjustment	275lbs / 125kg	Titanium	106g	23mm	23mm
	 1K209	4-hole Pyramid Socket Adapter features European 4-hole pattern and a pyramid adapter allowing for tilt adjustment of the socket	275lbs / 125kg	Titanium	46g	22mm	8mm
	 1K14	Ø 30mm Tubular Link providing connection between a 30mm Ø tube and a socket with a 4-hole plate	220lbs / 100kg	Aluminum	60g	32mm	32mm





CONTACT US

ORDER

# 4-HOLE ADAPTER

## COMPONENTS

### 4-Hole Lamination Adapters

	Use	Material	Weight	Max. Patient Weight	Item N°.
	<p><b>Threaded Four Hole Lamination Adapter With One-Way Valve</b> A threaded 4-hole adapter plate with one-way valve. Kit includes #10 plate, TP5 valve, and four attachment screws</p>	Aluminum	103.6g	300lbs 136kg	FHLA-10K
	<p><b>Threaded Four Hole Lamination Adapter With One-Way Valve</b> A threaded 4-hole adapter plate with one-way valve. Kit includes #10 plate, TP3 valve, and four attachment screws</p>	Aluminum	103.6g	300lbs 136kg	FHLA-10KT-P3SB
	<p><b>Threaded Four Hole Lamination Adapter With One-Way Valve</b> A threaded 4-hole adapter plate with one-way valve. Kit includes #16 plate; 1 - TP7 &amp; 1 - TP10 valve</p>	Aluminum	93.2g	300lbs 136kg	FHLA-16K
	<p><b>Threaded Four Hole Lamination Adapter</b> A threaded 4-hole adapter plate. Compatible with TP9, TP5 and TP3 valves</p>	Aluminum	98.9g	300lbs 136kg	FHLA-10

CONTACT US

ORDER



# 4-HOLE ADAPTER

## COMPONENTS

### 4-Hole Lamination Adapters

	Use	Material	Weight	Max. Patient Weight	Item N°.
	<p><b>Threaded Four Hole Lamination Adapter</b> Standard 65mm hole pattern. Dimensions: 72 x 11mm</p>	Aluminum	60.96g	300lbs 136kg	FHLA-11
	<p><b>Threaded Four Hole Lamination Adapter</b> A low-profile, threaded 4-hole adapter plate. Dimensions: 72 x 9.5mm Compatible with TP9, TP5 and TP3 valves</p>	Aluminum	53g	300lbs 136kg	FHLA-13
	<p><b>Threaded Four Hole Lamination Adapter</b> Standard 65mm hole pattern. Dimensions: 69 x 9.5mm</p>	Aluminum	56.7g	300lbs 136kg	FHLA-3
	<p><b>Threaded Four Hole Lamination Adapter</b> M6 threaded blind holes. Plate has no through holes. Dimensions: 72 x 15mm</p>	Nylon	56.7g	300lbs 136kg	FHLA-23
	<p><b>Threaded Four Hole Lamination Adapter</b> M6 threaded blind holes. Plate has no through holes. Dimensions: 72 x 15mm</p>	Nylon	60g	300lbs 136kg	FHLA-24

CONTACT US

ORDER



1236 West Southern Avenue #101, Tempe, AZ 85282 • 855.450.7300

[shop.proteorusa.com](http://shop.proteorusa.com)     #HumanFirst

#HUMANFIRST

# SOCKETS TECHNOLOGY

## TABLE OF CONTENTS

**Keasy**



**PREFAB CONE**

**STEPLINE PLUS**



**SEALING SLEEVES**



**SEALING RING**



**ADJUSTABLE TEMPORARY SOCKET**



**STEP-IN**



### **LOCKS AND VALVES**

- Valve for thermoformable transfemoral socket
- Valve for Aluminum transfemoral socket
- Accessories for transfemoral valve
- Depressurizing valves
- Locks for distal attachment
- Tools and accessories for lock



### **COSMETICS**

- Transfemoral 2-part cosmetic cover
- Polyethylene & Polyurethane one-part cosmetic cover
- Plastazote one-part cosmetic cover

**CONTACT US**

**ORDER**

# LINERS

SOCKETS



**KEASY has established itself over the years as the unique prefabricated cone allowing to manufacture rapidly quality finished thermoformed liners.**

A unique prefabricated cone, the **KEASY** has established itself due to the offered ability to rapidly create quality, finished thermoformed liners.

No welding, no gluing, and seamless, the **KEASY** minimizes allergenic risks while providing comfort. Fabrication and finishing time are shortened with easy thermoforming, cutting and sanding abilities. Changes in limb volume can be accommodated by gluing extra material to the outer surface. Closed cell structure keeps perspiration and cleaning products from penetrating the material for easy cleaning.

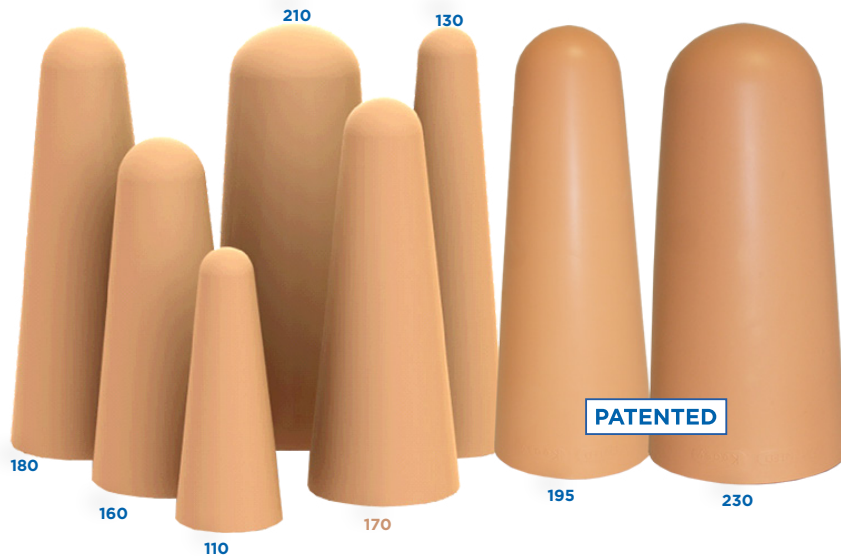

Item N°.	Use	Length	Ø Proximal	Profile	Distal Thickness	Packaging
<b>Keasy Comfort</b>						
1S402-110#12	BK small Upper limb	305mm	110mm	5mm	8mm	x 12
1S400-130#24	BK, Long & thin	500mm	130mm	6,5mm	10mm	x 24
1S400-160#24	BK Short & medium	400mm	160mm	6,5mm	10mm	x 24
1S400-180#12	BK Short & medium	500mm	180mm	6,5mm	15mm	x 12
1S400-195#9	BK XL	510mm	195mm	6,5mm	10mm	x 9
1S400-210#6	AK	500mm	210mm	6,5mm	10mm	x 6
1S400-230#6	AK XL	510mm	230mm	6,5mm	10mm	x 6
<b>Keasy interface</b>						
1S401-170#12	BK Short & medium	420mm	420mm	3mm	10mm	x 12



CONTACT US

ORDER



1236 West Southern Avenue #101, Tempe, AZ 85282 • 855.450.7300

shop.proteorusa.com #HumanFirst

#HUMANFIRST

# SEALING SLEEVES

SOCKETS

## STEPLINE PLUS

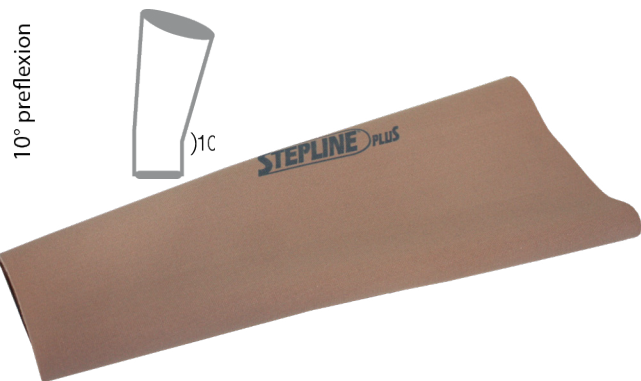

### STEPLINE PLUS Sealing Sleeve

The **STEPLINE PLUS** sealing sleeve is made from our copolymer gel and features a durable fabric outer-covering that offers great durability and flexibility. The **STEPLINE PLUS** is available in two colors.



Item N°.	Material	Length	Profile	Distal Circumference	Proximal Circumference	Color
1S500-M	Copolymer Gel	350mm	3mm uniform	21 to 30cm	29 to 43cm	Beige
1S500-L				28 to 48cm	36 to 51cm	
1S500-LP				31 to 46cm	39 to 55cm	
1S500-XL				34 to 50cm	42 to 60cm	
1S500-XXL				36 to 55cm	44 to 70cm	
1S510-M				21 to 30cm	29 to 43cm	Grey
1S510-L				28 to 48cm	36 to 51cm	
1S510-LP				31 to 46cm	39 to 55cm	
1S510-XL				34 to 50cm	42 to 60cm	
1S519-XXL				36 to 55cm	44 to 70cm	

### STEPLINE PLUS PREFLEX Sealing Sleeve

Sealing sleeve with 10° pre-flexion. Designed to minimize discomfort during flexion.

Item N°.	Material	Length	Profile	Distal Circumference	Proximal Circumference	Color
1S520-S	Copolymer Gel	340mm	3mm uniform	28 to 48cm	36 to 51cm	Beige
1S520-M				31 to 46cm	39 to 55cm	
1S520-L				34 to 50cm	42 to 60cm	
1S520-XL				36 to 55cm	44 to 70cm	

CE

CONTACT US

ORDER

# SEALING SLEEVES

SOCKETS

## Sealing Ring

This silicone sealing ring has to be bonded onto the liner of lower or upper limb amputees.

By creating vacuum between the socket and the liner, it provides the prosthesis suspension through depressurization for patients without locking device. Available in 4 sizes (from 2 to 5) it is suitable for any case.



### TECHNICAL FEATURES

Item N°.	Size	Ø Distal	Adhesive included
1S950-02	2	16 to 22 cm	yes
1S950-03	3	20 to 38 cm	yes
1S950-04	4	30 to 48 cm	yes
1S950-05	5	40 to 55 cm	yes
1S950-12	2	16 to 22 cm	no
1S950-13	3	20 to 38 cm	no
1S950-14	4	30 to 48 cm	no
1S950-15	5	40 to 55 cm	no

### ADDITIONAL ITEMS

Item N°.	Description
XC950	Glue for sealing ring
1S950-90	Spray donning Aid for sealing ring



CONTACT US

ORDER

# SOCKETS

SOCKETS

## Adjustable Temporary Socket

This socket with adjustable closing allows an easy fitting for patients with recent transfemoral amputation.





- A wide range of adult and child sizes
- A suspension system is necessary (suspenders)
- We strongly recommended to protect the residual limb with cotton tubular jersey



### TECHNICAL FEATURES

Item N°.	Side	Item N°. line	Circumference of residual limb base	Height Perineum / Socket End	Lower Connection	Use
1N06-G... or 1N06-D...	G = Left D = Right	3438	34 to 38cm	26.5cm	1N106	Adult
		3943	39 to 43cm			
		4448	44 to 48cm			
		4953	49 to 53cm			
		5458	54 to 58cm			
1N07-G... or 1N07-D...	G = Left D = Right	5963	59 to 63cm	21.5cm	1N107	Child
		3033	30 to 33cm			
		3438	34 to 38cm			

### ORDER ONE OF THE FOLLOWING TO COMPLETE YOUR ORDER

	Item N°	Description
	1N106	Linking Device for Temporary Adult Prosthesis
	1N107	Linking Device for Temporary Child Prosthesis
	TJ001/2/3/4/5	Cotton Tubular Jersey
	1X170	Suspenders for Temporary Prosthesis

CE

CONTACT US

ORDER

# SOCKETS

SOCKETS

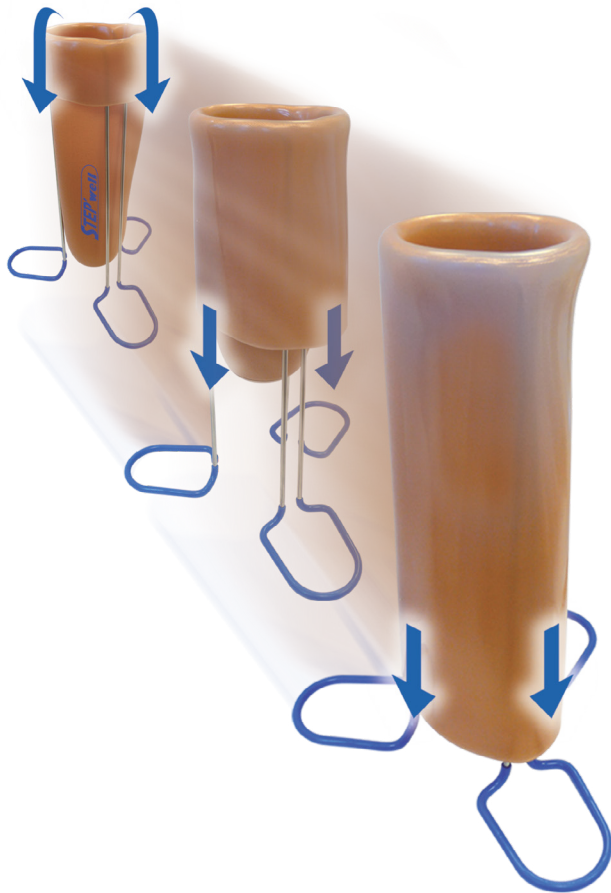

## Step-In

Step-in is a multi-purpose support designed to easily reflect and assist in donning liners of any kind (copolymer gel, silicone gel, silicone, etc).

- Facilitates donning, drying, and cleaning of the liner
- Height: 39cm

Item N°.	Packaging
1S900	Unit
1S900#5	Set of 5





CONTACT US

ORDER

# LOCKS & VALVES

## SOCKETS

### Depressurizing Valves

	Use	Description	Item N°.
	<p><b>Depressurizing Valves for Transtibial Socket</b> Allows a firm suspension of the prosthesis onto the residual limb, due to automatic air expulsion Easy to use for the patients</p>	Valve for BK Socket	1S162
	<p><b>Depressurizing Valves for Transfemoral Socket</b> Allows a firm suspension of the prosthesis onto the residual limb, thanks to manual air expulsion or automatic one. The cap has a quick opening system (1/4 turn), allowing to use a putting on aid for the prosthesis. Easy to use for the patient. A specific tool (1S164) can be used to set up the valve</p>	Valve for AK Socket	1S163
	<p><b>Specific Tool</b> Allows to set up, remove and configure (manually or automatically) transfemoral valve 1S163</p>	Tool for 1S163 depressurizing Valve	1S164

CONTACT US





ORDER



# LOCKS & VALVES

## SOCKETS

### Valves for Thermoformable Transfemoral Socket

	Use	Item N°.	Valve
	<p><b>Valve Seat for Thermoformed Socket</b> This valve seat will be placed on the positive model and fixed while socket thermoforming The assembly is sealed by a joint</p>	1X21	
	<p><b>Removable Valve Seat</b> This seat valve will be fitted on thermoformable rigid plastics or soft plastics which will be laminated afterwards Use 1X4750 tool to set up</p>	1X47	 1X16: Ø 30mm Silicone Valve
	<p><b>Valve Seat and Removable Seat</b> This seat valve will be fitted on thermoformable rigid plastics or soft plastics which will be laminated afterwards Use 1X10150 tool to set up 1X10158 wrench allows to screw the valve to the seat valve 1X10159 wrench allows to fit the seat valve on the socket</p>	1X10140	Included

### Accessories for Transfemoral Valves

	Use
	<p><b>1X45 Rigid Hole Shuttle Housing</b> To be glued on a wooden or laminated traditional socket</p>



CONTACT US

ORDER

# LOCKS & VALVES

SOCKETS

## Locks for Distal Attachment

	Use	Material	Weight	Max. Patient Weight	Item N°.
	<p><b>Push Lock Kit.</b> Our best selling puck-style lock with a 2.50" pin Includes (2) 2.5" lock pins and (4) M6x1.0x25 water resistant. FHCS</p>	Plastics + Aluminum	102g	365lbs 166kg	LOC-APC-2.50
	<p><b>Push Lock Kit.</b> Our best selling puck-style lock with a 1.75" pin Includes (2) 1.75" lock pins and (4) M6x1.0x25 water resistant. FHCS</p>	Plastics + Aluminum	102g	365lbs 166kg	LOC-APC-1.75
	<p><b>Push Lock Kit.</b> Our best selling puck-style lock with 1.25" pin Includes (2) 1.25" lock pins and (4) M6x1.0x25 water resistant. FHCS</p>	Plastics + Aluminum	102g	365lbs 166kg	LOC-APC-1.25





CONTACT US

ORDER

# LOCKS & VALVES

## SOCKETS

### Locks for Distal Attachment

	Use	Material	Weight	Tools & Accessories		Item N°.	
	<p><b>Locking Kit with Smooth Pin, Small Cup and Adapter for 1K90</b>            This kit with push button and smooth pin is fitted with a device that locks the pin, allowing accurate positioning.            Thanks to its small cup (Ø 57mm), it is particularly appropriate for residual limbs with low volume, such as transtibial ones. It is designed for assembly with 1K90 cup which is not included in the kit.</p>	Plastics	100g	1S129: Tools for Lamination / Thermoforming 1S112: Centering Tool		1S137-1	
	<p><b>Locking Kit with Smooth Pin and Vertical Pulling</b>            This locking kit with pin is operated by vertical tab pulling.            Control of unlocking can be displaced through a handle fitted on the side of the socket.            2 pins are supplied:            A smooth pin that provides fine adjustment of the liner, and a smooth pin with notched end allowing the patient to know if the pin is well engaged and providing accurate adjustment. Ø 45mm cup.</p>	Plastics + Aluminum	85g	1S141: Tools for Lamination / Thermoforming 1S129: Tool for Lamination / Thermoforming, used with 1S142 1S112: Centering Tool 1S142: Adapting Kit for assembly with 1K90 cup 1X110: Handle for displaced control of unlocking		1S140	
	<p><b>Locking Kit with Notched Pin and Rack Adjustment</b>            1S145 locking kit provides very fine adjustment thanks to its rack system which avoids any slack in the bottom of the socket. It comes with a lamination prong for the upper connection and the tools needed for lamination. The lower connection is provided by screwing a threaded pyramid insert (1K182) or a threaded Receiver insert (1K183).</p>	Aluminum + Stainless steel	125g	1K182: Threaded Pyramid insert 1K183: Threaded Receiver insert		1S145	
	<p><b>Smooth Pin</b></p>	-	-	Pin length	30mm	1S11632	
					36mm	1S11636-1	
					50mm	1S11633	









CONTACT US

ORDER

# LOCKS & VALVES

## SOCKETS

### Tools and Accessories for Locks

	Use	Material	Weight	Item N°.
	<p><b>European 4-Hole plate</b> This cup allows to fit any European 4-hole linking component (4 x M6, 36mm) on a knee. Comes with its protective tools.</p>	Aluminum	75g	1S105
	<p><b>Centering Tool</b> Fitted on the end of a positive model previously slightly leveled, the 1S112 tool allows to install a pin lock. It will be taken off (for re-use) when the positive model is broken down. Used for item No 1S103, 1S116-1, 1S117-1, 1S136-1, 1S137-1, 1S140</p>	Plastics	-	1S112
	<p><b>Forming Tool for 1S116-1</b> 1S118-1 tool allows to keep enough space at the bottom of the socket to receive 1S116-1 locking kit with smooth pin.</p>	Plastics	-	1S118-1
	<p><b>Forming Tool for 1S117-1</b> 1S119-1 tool allows to keep enough space at the bottom of the socket to receive 1S117-1 locking kit with smooth pin.</p>	Plastics	-	1S119-1
	<p><b>Forming Tool for 1S136-1</b> 1S128 tool allows to keep enough space at the bottom of the socket to receive 1S136-1 locking kit with smooth pin and adapter.</p>	Plastics	-	1S128
	<p><b>Tools for 1S140</b> This tooling kit allows to keep enough space at the bottom of the socket to receive 1S140 locking kit. It comes with a short and a long pipe used according to the type of endoskeletal or exoskeletal socket. A drilling and screwing set is also supplied for easier assembling of the different items.</p>	Special treated steel		1S141







CONTACT US

ORDER

# LOCKS & VALVES

## SOCKETS

### Tools and Accessories for Locks

	Use	Material	Weight	Item N°.
	<p><b>Adapting Kit for Assembly on a Cup</b>                      1S142 adapting kit allows to fit 1S140 locking kit with pin on 1K90 cup (not included in the kit).                      This kit includes a Ø 57mm cup and the screws needed to assemble the items.                      The use of 1S129 tool is necessary.</p>	Plastics	15g	1S142
	<p><b>Socket Mounted Mechanical Knee Lock Release</b>                      1X110 handle allows to displace control of unlocking to a place that is more accessible for the patient.                      It is appropriate for 1M102V and 1M102V-HD locking knees.</p>	Plastics	25g	1X110
	<p><b>Threaded Pyramid Insert</b>                      This pyramid is screwed to the lower end of 1S145 lock.</p>	Plastics	65g	1K182
	<p><b>Threaded Receiver Insert for 1S145 Lock</b>                      This receiver is screwed to the lower end of 1S145 lock.                      Threaded Receiver Insert for 1S145 Lock</p>	Plastics	75g	1X183



CONTACT US

ORDER

# COSMETICS

SOCKETS

## Transfemoral 2-part Cosmetic Cover

- Does not interfere with knee unit or its settings
- Lets clothing slip on the cosmetic cover without snagging it



### TECHNICAL FEATURES

Shin Item N°	Knee Cap Item No	Knee
1G21	-	1M01 / 1M10 / 1M01-HD / 1M10-HD
1G21	1M10294	1M102 / 1M102V / 1M102-HD / 1M102V-HD

### JUNCTION PLATES

Item N°	Foot
1D20	S.A.C.H.
1D26	Child

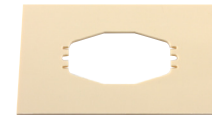



CONTACT US

ORDER

# COSMETICS

## SOCKETS

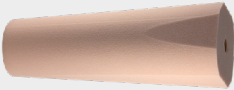
### Polyethylene & Polyurethane One-part Cosmetic Cover

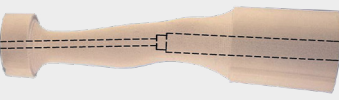
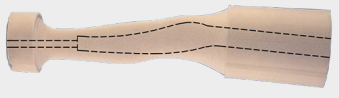
	Item N°	Length	Color	Material	Diameter	Prosthesis	Packaging
	1G14	545mm	Light	Polyurethane	max 200mm	BK	x 1
	1G17	480mm		Polyethylene	Shin 147mm Ankle 100mm	BK	x 1
	1G17#12						x 12
	Left 1G13-G32	900mm	Light	Polyurethane	320mm	1M01 1M01-HD 1M10 1M10-HD 1M102 1M102-HD 1M102V 1M102V-HD 1M03 1M05 1M112 1M113 1M115 1M149	x 1
	Right 1G13-D32				360mm		
	Left 1G13-G36				400mm		
	Right 1G13-D36				440mm		
	Left 1G13-G40						
	Right 1G13-D40						
	Left 1G18-G36	900mm	Light	Polyurethane	360mm	1P200 1P350 1P130	x 1
	Right 1G18-D36				400mm		
	Left 1G18-G40				440mm		
	Right 1G18-D40						
	Left 1G18-G44						
	Right 1G18-D44						

CONTACT US



ORDER

# COSMETICS

SOCKETS

## Plastazote One-part Cosmetic Cover

Both cosmetic covers are thermoformable at 100°.

	Prosthesis	Length	Color	Material	Diameter	Item N°	Packaging
	BK	<b>590mm</b>	Light	Plastazote	Proximal 170mm Distal 100mm	1G1510	x 1
	AK	<b>245mm</b>	Medium	Polyurethane	max 235mm	1G1525	x 1
	AK	<b>510mm</b>	Light	Plastazote	Proximal 190mm Distal 125mm	1G24	x 1

CONTACT US

ORDER



# MATERIALS & FABRICATION

## TABLE OF CONTENTS

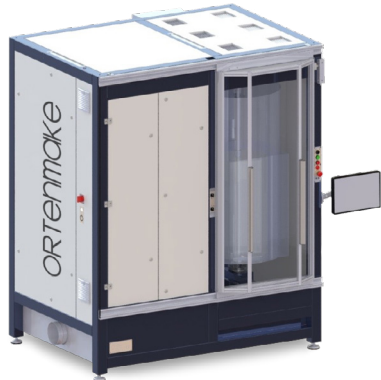

**MILLING MACHINES**



**ANKLE JOINTS**



### **STRAPS AND PADS**

- Textured and colored Straps and pads
- Customized pvc strap
- Fabric strap
- Velvet strap
- Micro-hook strap
- Hook and loop strap



### **FABRICS**

- Special thermoformable fabric
- Thermoformable thick fabric
- 3D fabric
- Single layer 3d fabric waterproof
- Ripstop suede fabric
- Neoprene sheet
- Anti-slipping lining
- Waterproof & stretchable fabric
- Lycra® fabric
- Terry cloth
- Self-adhesive suede fabric
- Self-adhesive fabric
- Self-adhesive carbon imitation
- Padding felt
- Elastic velvet edge
- Thread



**FASTENERS**



**TOOLS**

**CONTACT US**

**ORDER**

# MILLING MACHINES

MATERIALS

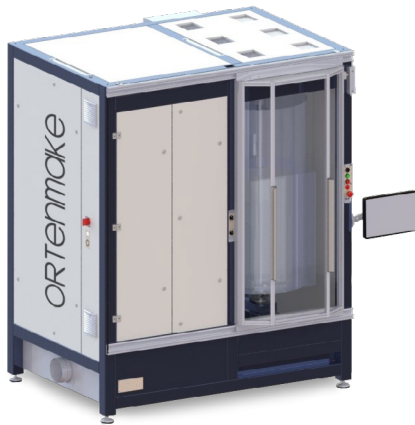

## The Milling Solution Adapted To Your Needs

Qualitative, fast and easy milling of any orthopedic device, even complex shapes, becomes possible using **OrtenMAKE** milling machines. The latest generation of OrtenMAKE milling machines demonstrates every day their sturdiness and performance.

- If you have any issue, our **OrtenMAKE** expert center is at your disposal
  - Analysis of your request and intervention
  - Implementation of the solution and control of the resolution
- 2-year warranty
- Continuous investment in product innovation, positioning you for the future

### TECHNICAL FEATURES

Model	# Axis	Half-axis	Undercut	Table	Orthotic Device Examples	Dimensions
OrtenMAKE Classic	3	No	No	No	Spinal orthosis, AK/BK socket(with through-hole)	Width: 1860 mm Depth: 1560 mm Height: 2005 mm
OrtenMAKE Complete	4	Yes	Yes	No	Spinal orthosis, AK / BK socket, A.F.O. / K.A.F.O., Cranial remolding orthosis, Neck brace	Width: 1860 mm Depth: 1560 mm Height: 2005 mm

CONTACT US

ORDER



1236 West Southern Avenue #101, Tempe, AZ 85282 • 855.450.7300

shop.proteorusa.com [f](#) [t](#) [i](#) [m](#) #HumanFirst

#HUMANFIRST

# ANKLE JOINTS

## MATERIALS



### A complete line of flexure joints, let Aflex help fabricate your all your thermoformed orthoses

- Indications: to treat pathologies of neurological, muscular or traumatic origin that affect foot levator muscles
- Easy implementation thanks to their flexibility allowing self-alignment
- Designed to last, Aflex has been tested in all conditions and guaranteed meet your needs

#### Flexible AFLEX

Recommended for night AFO, their flexibility ensures comfort for even very spastic patients and possible motions of the ankle allow a better compliance of the orthosis. (3 sizes available (pediatric, child, adult))



Description	Pediatric	Child	Adult
<b>L x W</b>	34 x 11,6mm	42 x 11,7mm	49 x 14mm
<b>Thickness</b>	5mm	6,5mm	8mm
<b>Item N°. kit</b>	2C131-P	2C131	2C130

#### Reinforced Straight AFLEX

Recommended for walking AFO, they prevent planti-flexion of the foot and motion in rotation and inversion-eversion of the foot. Reinforced with a Kevlar fiber braid: Superior Tensil Strength (2 sizes available child, adult).



Description	Child	Adult
<b>L x W</b>	40 x 14mm	44 x 16mm
<b>Thickness</b>	9mm	
<b>Item N°. kit</b>	2C161	2C160

#### Reinforced Dorsi AFLEX

Recommended for walking AFO with Dorsi Flexion assist. The natural yield of the joint provides a motion assistance in Dorsi Flexion during swing phase to supply toe clearance. Reinforced with a Kevlar fiber braid: Superior Tensil Strength. 3 durometers available to give a better answer for patient needs (70, 80 and 90 ShA). 2 sizes available (child, adult).

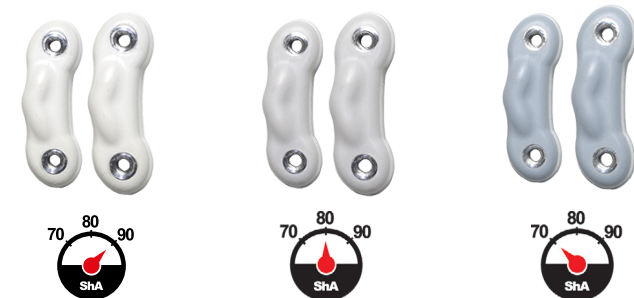

Description	White 90 ShA		Light grey 80 ShA		Dark grey 70 ShA	
	Child	Adult	Child	Adult	Child	Adult
<b>L x W</b>	40 x 14mm	44 x 16mm	40 x 14mm	44 x 16mm	40 x 14mm	44 x 16mm
<b>Thickness</b>	9mm					
<b>Item N°. kit</b>	2C163-90	2C162-90	2C163-80	2C162-80	2C163-70	2C162-70



CONTACT US

ORDER



1236 West Southern Avenue #101, Tempe, AZ 85282 • 855.450.7300

shop.proteorusa.com #HumanFirst

#HUMANFIRST

# STRAPS AND PADS

## MATERIALS

### A Full Range of Straps and Pads, Including Chafe and Loop

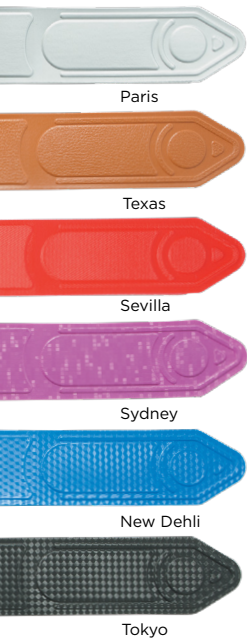

TEXTURED

Pack.	Length	SELF-GRIPPING STRAP					PVC PAD	
		300mm		500mm	400mm	680mm	150mm	
		16mm	25mm		40mm	25mm	40mm	
x 10	<b>Paris</b>	2X716-CV300	2X416-CV300	2X416-CV500	2X516-CV400	2X516-CV680	2X814	2X614
x 10	<b>Texas</b>	2X79-CV300	2X49-CV300	2X49-CV500	2X59-CV400	2X59-CV680	2X89	2X69
x 100	<b>Texas marked</b>	2X79-CC300	2X49-CC300	2X49-CC500	2X59-CC400	2X59-CC680		
x 10	<b>Sevilla</b>	2X709-CV300	2X409-CV300	2X409-CV500	2X509-CV400	2X509-CV680	2X805	2X605
x 100	<b>Sevilla marked</b>	2X709-CC300	2X409-CC300	2X409-CC500	2X509-CC400	2X509-CC680		
x 10	<b>Sydney</b>	2X701-CV300	2X401-CV300	2X401-CV500	2X501-CV400	2X501-CV680	2X801	2X601
x 10	<b>New Dehli</b>	2X702-CV300	2X402-CV300	2X402-CV500	2X502-CV400	2X502-CV680	2X802	2X602
x 10	<b>Tokyo</b>	2X70-CV300	2X40-CV300	2X40-CV500	2X50-CV400	2X50-CV680	2X85	2X65
x 100	<b>Tokyo marked</b>	2X70-CC300	2X40-CC300	2X40-CC500	2X50-CC400	2X50-CC680		
x 10	<b>Alaska</b>	2X75-CV300	2X45-CV300	2X45-CV500	2X55-CV400	2X55-CV680	2X81	2X61
x 10	<b>Moscou</b>	2X713-CV300	2X413-CV300	2X413-CV500	2X513-CV400	2X513-CV680	2X818	2X618
x 10	<b>Oslo</b>	2X719-CV300	2X419-CV300	2X419-CV500	2X519-CV400	2X519-CV680	2X83	2X63
x 100	<b>Oslo Marked</b>	2X719-CC300	2X419-CC300	2X419-CC500	2X519-CC400	2X519-CC680		
x 10	<b>Shanghai</b>	2X721-CV300	2X421-CV300	2X421-CV500	2X521-CV400	2X521-CV680	2X809	2X609
x 100	<b>Shanghai marked</b>	2X721-CC300	2X421-CC300	2X421-CC500	2X521-CC400	2X521-CC680		
x 10	<b>Auckland</b>	2X714-CV300	2X414-CV300	2X414-CV500	2X514-CV400	2X514-CV680	2X819	2X619
x 100	<b>Auckland marked</b>	2X714-CC300	2X414-CC300	2X414-CC500	2X514-CC400	2X514-CC680		
x 10	<b>Amsterdam</b>	2X708-CV300	2X408-CV300	2X408-CV500	2X508-CV400	2X508-CV680	2X808	2X608
x 100	<b>Amsterdam marked</b>	2X708-CC300	2X408-CC300	2X408-CC500	2X508-CC400	2X508-CC680		
x 10	<b>Lima</b>	2X71-CV300	2X41-CV300	2X41-CV500	2X51-CV400	2X51-CV680		
x 100	<b>Lima marked</b>	2X71-CC300	2X41-CC300	2X41-CC500	2X51-CC400	2X51-CC680		
x 10	<b>London</b>	2X77-CV300	2X47-CV300	2X47-CV500	2X57-CV400	2X57-CV680		



COLORED



#### CUSTOMIZATION

100 pieces minimum in same size and color.

Please, contact us to get an estimate, from 100 straps.

CONTACT US

ORDER

# STRAPS AND PADS

## MATERIALS



### Customized PVC Strap

Pack.	SELF-GRIPPING STRAP			PVC PAD	
	Length	300mm	400mm	150mm	
	Width	25mm	40mm	25mm	40mm
x 10	Ladybug	2X412-CV300R	2X512-CV400R	2X812	2X612
x 10	Syxtty Flower	2X411-CV300R	2X511-CV400	2X811	2X611
x 10	Jean	2X410-CV300R	2X510-CV400R	2X810	2X610

### Fabric Strap

- Flexible, comfortable and washable
- Ideal for areas sensitive to rubbing
- One size. Can be easily cut with scissor.
- Delivered with roller chafe to facilitate the sliding of the strap

Pack.	Length	290 + 125mm	290 + 125mm
	Width	25mm	40mm
x 10	Item N°.	2X100-2525	2X100-4025

### Velvet Strap

- Flexible, comfortable and washable strap
- It is ideal for friction sensitive areas
- Better comfort thanks to the built-in flap
- Impressive gripping strength thanks to the micro hook
- Delivered with roller chafe to facilitate the sliding of the strap

Pack.	Width	25mm	40mm
	Item N°.	2X098-2525	2X098-4025
x 10			

### Micro-Hook Strap

- Velvet-hemmed loop band, associated with our micro hook pliers
- Optimal implementation: can be cut to the desired length
- Delivered with roller chafe to facilitate the sliding of the strap

Pack.	Width	25mm	40mm
	Item N°.	2X099-25	2X099-40
x 10			







CONTACT US

ORDER

# FABRICS

## MATERIALS

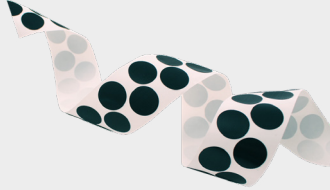
### Hook and Loop Strap

								
<b>Comfort Pad</b>	<b>Elastic Loop Strap</b>		<b>Micro-hook</b>		<b>Plastic Disc with Hooks</b>			
<ul style="list-style-type: none"> <li>- Provides comfort in areas sensitive to rubbing.</li> <li>- The hooks on one side make it easy to attach to loop.</li> <li>- 2X100-NS with silicone to prevent the orthosis from slipping.</li> <li>- Easy cutting.</li> <li>- Particularly adapted to 2x100-4025</li> </ul>	<ul style="list-style-type: none"> <li>- Adjustable and variable compression.</li> <li>- Perfectly matches the skin relief.</li> <li>- Easy cutting.</li> </ul>		<ul style="list-style-type: none"> <li>- Very flat, soft to the touch.</li> <li>- Exceptional gripping capacity.</li> <li>- Bonds easily to many supports like polyethylene, polypropylene, PVC, polyamide, wood, glass, cardboard, metal.</li> <li>- Precut round pieces.</li> <li>- Adhesive side for immediate bond, optimal after 24h.</li> </ul>		<ul style="list-style-type: none"> <li>- Very strong grip.</li> <li>- Can be screwed in the plastic device (screws included).</li> </ul>			
Width	50mm		25mm	50mm	Ø 15mm	Ø 25mm	Ø 25mm	
Length	1m		25m		-		-	
Color	Black	Black with silicone	White		Black	Black	Transparent	Black
Item N°	2X100-N	2X100-NS	TT190-25	TT190-50	TT216-15	TT216-25	TT215-25	2X980
Packaging	by meter	10m	x 1		x 800	x 400	25m	10 discs + 10 screws

CONTACT US

ORDER





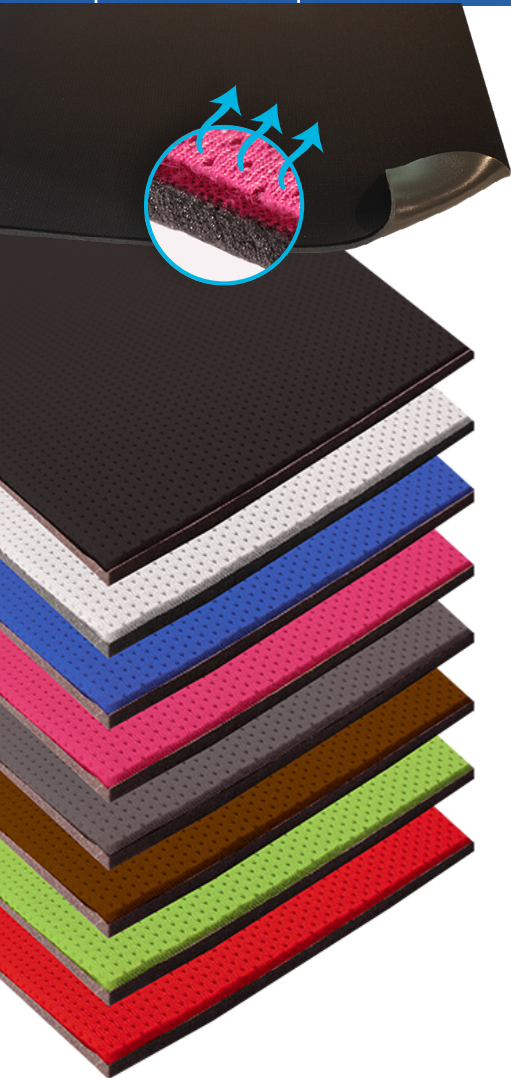



# FABRICS

## MATERIALS



### Special Thermoformable Fabric

- Breathable, textured, moisture wicking fabric
- Very comfortable and soft to the touch
- Easy to clean, washable at 40°C
- Good resistance to aging
- Glue-less, this fabric limits risks of allergy
- Thermoformable at 170°C

Thickness	6mm	Width	1.45m	Length	1.00m		
							
Black	White	Blue	Raspberry	Lead gray	Brown	Green	Red
TT501	TT502	TT503	TT504	TT505	TT506	TT507	TT508

### Thermoformable Thick Fabric

- Perfectly matches the most complex mold shapes
- Very comfortable and soft to the touch
- Easy to clean, washable at 40°C
- Good resistance to aging
- Glue-less, this fabric limits risks of allergy
- Thermoformable at 170°C

Thickness	6mm	Width	1.45m	Length	1.00 m		
							
Black	Blue	Fuchsia					
PL190-06	PL191-06	PL192-06					



CONTACT US

ORDER









# FABRICS

## MATERIALS









### 3D Fabric

- Breathable, textured, moisture wicking fabric
- Very comfortable and soft to the touch
- Easy to clean, washable at 40°C
- Good resistance to aging
- Glue-less, this fabric limits risks of allergy

Thickness	6mm	Width	1.45m	Length	by meter		
							
Black	White	Blue	Raspberry	Lead gray	Brown	Green	Red
TT381	TT382	TT383	TT384	TT385	TT386	TT387	TT388

### Single Layer 3d Fabric Waterproof

- Stretchable, breathable, comfortable 3D fabric
- Waterproof thanks to the associated flexible film
- Very comfortable and soft to the touch
- Ideal for making covers with waterproof areas

Thickness	3mm	Width	1.45m	Length	by meter		
							
Black	White	Blue	Raspberry	Lead gray	Red		
TT391	TT392	TT393	TT394	TT395	TT396		



CONTACT US

ORDER



# FABRICS

## MATERIALS

									
<b>Ripstop Suede Fabric</b>		<b>Neoprene Sheet</b>		<b>Anti-slipping Lining</b>		<b>Waterproof &amp; Stretchable Fabric</b>		<b>Lykra Fabric</b>	
<ul style="list-style-type: none"> <li>- Its texture allows it to have strong resistance and velvet soft touch.</li> <li>- Very comfortable contact, soft and flexible to the touch.</li> <li>- Easy to clean, washable up to 40°C.</li> <li>- Good resistance to aging.</li> </ul>		<ul style="list-style-type: none"> <li>- Particularly suitable for lining orthosis and the confection of plastron.</li> <li>- Neoprene sheet with one side in polyester fabric, the back side can be fixed with hook.</li> <li>- Easy to clean, washable up to 40°C.</li> </ul>		<ul style="list-style-type: none"> <li>- Particularly suitable for lining of orthosis closure bands.</li> <li>- This copolymer provides optimal adhesion to the patient skin, the back side can be fixed with hook.</li> <li>- Relieves friction spots.</li> <li>- Easy to clean with water and soap.</li> </ul>		<ul style="list-style-type: none"> <li>- Particularly suitable for making waterproof covers.</li> <li>- Extensibility (bi stretch).</li> <li>- Excellent mechanical strength.</li> <li>- Easy to clean, washable at 40°C for TT372 and up to 90°C for TT373#10.</li> </ul>		<ul style="list-style-type: none"> <li>- Particularly suitable for making covers.</li> <li>- Extensibility (bi stretch).</li> <li>- Excellent mechanical strength.</li> <li>- Easy to clean, washable at 40°C.</li> <li>- Dries faster than an ordinary fabric.</li> </ul>	
Thickness	4,5mm		5mm		5mm		2,5mm	1mm	-
Width	1,45m		1,45m		0,30m		1,45mm	1,45mm	1,5m
Length	by meter	10m	0,99m		0,30m		by meter	10m	10m
Item N°.	TT600	TT600#10	TT460		TT450		TT372	TT373#10	TT370#10
Packaging	by meter	10m	x 1		x 1		by meter	10m	10m

CONTACT US

ORDER

# FABRICS

## MATERIALS



### Terry cloth

- Particularly suitable for making covers.
- Ideal for lining.
- Stretchable in both directions.
- Easy to clean, washable up to 40°.

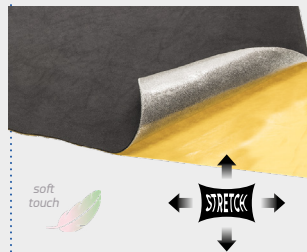

### Self-adhesive Suede Fabric

- It is recommended for inside or outside lining of orthosis.
- Very comfortable contact, soft and flexible to the touch.
- Fabric with a powerful adhesive.
- Good resistance to aging.

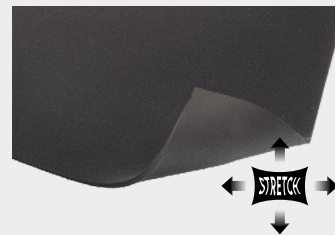

### Self-adhesive Fabric

- Ideal for inside or outside lining of orthosis.
- Very comfortable and soft to the touch.
- Fabric with a powerful adhesive.

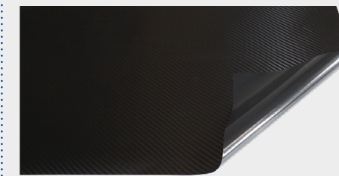

### Self-adhesive Carbon Imitation

- This vinyl is particularly recommended for the lining of orthosis.
- It allows the covering of any material in order to get a «carbon-fiber» appearance.
- Resistant and easy to apply (with a heat gun).
- Adhesive side for immediate bond, optimal after 24h.

### Padding Felt

- Particularly suitable for making covers.
- Extensibility (bi stretch).
- Excellent mechanical strength.
- Easy to clean, washable at 40°C.
- Dries faster than an ordinary fabric.

Thickness	2mm			1,5mm	1,5mm	-	2mm
Width	1,5m			1,5m	1,5m	1,52m	0,9m
Length	5m			by meter	by meter	1m	1m
Color	Blue ●	Pink ●	Black ●	Black ●	Black ●	Carbon imitation	White ○
Item N°.	TT550-5	TT551-5	TT552-5	TT410	TT400	TH001	TF001
Packaging	5 m			x 1	by meter	x 1	x 1

CONTACT US

ORDER

# FABRICS

## MATERIALS



### Elastic Velvet Edge

- Its elasticity makes it suitable for finishing of edges with complex shapes
- Very comfortable and soft to the touch
- Reduces risks of irritation caused by rough edges
- Can be stitched or glued on plastics

<b>Color</b>	Black	White	Blue	Fuchsia	Grey	Brown	Red	Green	Beige	
<b>Width</b>	25mm								22mm	
<b>Packaging</b>	25m									
<b>Item N°.</b>	TT020-N	TT020-BLANC	TT020-BLEU	TT020-F	TT020-G	TT020-M	TT020-R	TT020-V	TT020	TT025

### Thread



<b>Color</b>	White	Raw	Black	Blue	Fuchsia	Grey	Brown	Green	Red		
<b>Material</b>	Linen	Terylene	Polyester	Polyester	Polyester						
<b>Packaging</b>	50g	270g	235g	250g	235g						
<b>Item N°.</b>	TT050	TT055	TT056	TT051-1	TT056-N	TT056-B	TT056-F	TT056-G	TT056-M	TT056-V	TT056-R

CONTACT US

ORDER

# FASTENERS

## MATERIALS

### Colored Single Cap Speedy Rivet

Head	Ø 13mm	Tube	Ø 4mm	Pack.	x 100
------	--------	------	-------	-------	-------

								
<b>Color</b>	<b>Black</b>	<b>White</b>	<b>Blue</b>	<b>Fuchsia</b>	<b>Grey</b>	<b>Brown</b>	<b>Green</b>	<b>Red</b>
<b>Height</b>	15,6mm 12,4mm	15,6mm 12,4mm	15,6mm 12,4mm	15,6mm 12,4mm	15,6mm 12,4mm	15,6mm 12,4mm	15,6mm 12,4mm	15,6mm 12,4mm
<b>Item N°.</b>	KE100 KE200	KE101 KE201	KE102 KE202	KE103 KE203	KE104 KE204	KE105 KE205	KE106 KE206	KE107 KE207

### Single Cap Speedy Rivet

<b>Packaging</b>	<b>Head Ø</b>	6,6mm		8,5mm		9,5mm		10,5mm		12mm	
x 100	<b>Tube Ø</b>	2,5mm		3mm		3mm		3mm		3mm	
	<b>Height</b>	6mm	7mm	8mm	11mm	15,6mm	9,1mm	11mm	10mm		
	<b>Item N°.</b>	KE047	KE046	KE050	KE051	KE057	KE056	KE058	KE053		



### Double Cap Speedy Rivet

<b>Packaging</b>	<b>Head Ø</b>	10,7mm
x 100	<b>Tube Ø</b>	3mm
	<b>Height</b>	9,1mm
	<b>Item N°.</b>	KE052



### Press Studs (snap)

<b>Packaging</b>						
x 100	<b>Color</b>	<b>Steel</b>	<b>Black</b>	<b>White</b>	<b>Blue</b>	<b>Fuchsia</b>
	<b>Item N°.</b>	KE030	KE030-01	KE030-02	KE030-03	KE030-04



CONTACT US

ORDER

# TOOLS

## MATERIALS



### Scissors

Description	Length	Item N°.
Plaster cast scissors	240mm	5C100
Scissors	700mm	5C101
Dressmaker's scissors	170mm	5C110
Dressmaker's scissors	200mm	5C111



### Deburring Tool

Ideal for trimming and leveling edges and surfaces

Description	Item N°.
Trimming with 2 blades	5C425
10 spare blades	5C427



### Deburring Tool for Tubes

One side to trim inside and the other to trim outside

Description	Item N°.
Inside and outside trimming for 22 to 34mm Ø tubes	5C424

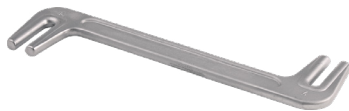

### Metal Forming Form

Jaw opening	Length	Item N°.
4 & 6mm	245mm	5D210
	310mm	5D220
6 & 8mm	245mm	5D211
	310mm	5D221
7 & 9mm	310mm	5D222

CONTACT US

ORDER

# PROTEOR TERMS OF SALE, RETURNS, & WARRANTIES

## TABLE OF CONTENTS

### 1.0 NEW ACCOUNTS

#### 1.1 How to Open an Account:

We establish an open account when you place your first order with PROTEOR (PROTEOR). We require a completed credit application prior to processing a second order. The review and approval process will normally take no longer than 24 hours from our receipt of your application. Orders must be pre-paid or shipped C.O.D. until credit has been established. Obtain a credit application by telephone at: 855.450.7300.

#### 1.2 How to Order:

You may place orders with PROTEOR in the USA, APAC, and Latin America by: Telephone: 855.450.7300 (Toll free, USA) Email: orders@proteorusa.com

#### 1.3 Order Information

When transmitting your order, please ensure that the order includes the following information.

- Part # or Item Description
- Quantity desired
- Order need by date
- “Ship to” address and phone number
- “Bill to” address (if it differs from “Ship to” address)
- Transportation mode desired (UPS Ground, 2-day, etc.)

Upon our receipt, thereof, our Customer Service Department will confirm the order and schedule it for shipment.

### 2.0 RETURN POLICY & PROCESS

#### 2.1 Returns, Direct Customers

##### 2.1.2 Return Authorization Number (RA#) Required

**A.** All returns require a Return Authorization Number (RA#). Call PROTEOR's USA Customer Service Department at 855.450.7300 for authorization. Be prepared to provide the Serial Number of product(s) you seek to return.

**B.** Place the provided Return Authorization Number inside and on the shipping container, on or near the shipping label. We will not accept returns without a RA#.

**2.1.3 Return Destination:** Authorized returns are to be shipped to the location address listed on the Return Authorization for the specific product.

**2.1.4 Return Opportunity:** We will not accept returns after 60 days from the invoice date. We do not accept returns for Knees or Microprocessor products.

**2.1.5 Return Documentation:** Send a copy of the original invoice or packing list and the customer return card with the returned product to ensure that you receive the replacement or credit for which you qualify. Failure to provide the required documentation may delay or prevent return processing.

**2.1.6 Responsibility:** Until PROTEOR receives the returned product, the Prosthetist remains responsible for the product and all related billing.

**2.1.7 Custom Orders:** Prosthetist is responsible for all shipping costs. We do not accept returns for orders (custom products). Custom orders are products of a Line, Style, Category, or Size not ordinarily stocked in our distribution facility.

#### 2.1.8 Products That Qualify for Return between 0 - 60 Days of Invoice Date:

- Kinterra
- ShockWave
- RUSH ROGUE 2
- RUSH HiPro
- RUSH Rover
- Highlander
- Highlander MAX
- RUSH Chopart
- Agilix
- Pacifica
- Pacifica LP
- DynAdapt
- RUSH Kid
- RUSH H2O Collection
- RUSH EVAQ8 Collection
- EasyRun
- Gery
- DynaStep
- Foot Shells
- Components
- Liners and Sealing Sleeves
- Sockets
- Locks and Valves
- Cosmetics
- Ankle Joints
- Straps and Pads
- Fabrics
- Fasteners
- Tools

**2.1.9 Resaleable Condition:** All products returned within 60 days of the invoice date will be evaluated to determine that they are in resaleable condition. Such products found to be damaged or not in resaleable condition shall be returned to the Customer, with no credit issued.

# PROTEOR TERMS OF SALE, RETURNS, & WARRANTIES

## TABLE OF CONTENTS

### 2.2 Types of Returns

**2.2.1 60-day Returns:** If a Customer is dissatisfied with standard stock products that are eligible for a Trial Period, they may return the product for size alteration, stiffness modification, or account credit if product is in resalable condition.

**A. Exceptions:**

- Special order sizes, category variations, and custom foot products are not eligible for returns.
- Microprocessor products are non-returnable: QUATTRO, Plie, Allux, and Kinnex
- Knees are non-returnable.

**2.2.2 Miscellaneous “No Replacement” Returns:** When a Customer does not place a reorder at the time the RA# is requested.

- We will accept all returns with RA#s issued between 0 and 60 days of the invoice date and will not charge a restocking fee if the product is in resalable condition.

**2.3 Account Credit:** We grant an account credit and apply it to the Customer’s account, pursuant to existing procedure or a negotiated agreement with the Customer (e.g., credit for returned goods, overpayments, duplicate payments, etc.).

## 3.0 WARRANTY POLICY & PROCEDURES

**3.1 Warranty Policy:** We guarantee all our products to be free from defects in material and workmanship. Any product found to be defective, when used in a customary and proper manner according to the product’s published Instructions for Use, shall at PROTEOR’s discretion be evaluated and replaced under warranty. All warranty replacements will be shipped in a timely manner accompanied by an invoice for the original purchase price. We will issue credit upon receipt of the product’s return to PROTEOR.

**3.2 Warranty Terms:** We calculate Warranty duration from the original invoice date.

**3.2.1 Ankle / Foot Modules:** 36-months

**A. Exceptions:**

- Gery Foot: 12-months
- DynaStep: 12-months
- EasyRun: 12-months
- RUSH Chopart: 24-months
- RUSH Kid: 18-months

**3.2.2 Foot Shells:** 6-months

**3.2.3 Microprocessor Ankles**

- **Kinnex:** No required service checks. Extended 2- year warranty option available when purchased within 12 months of the original invoice date.

**3.2.4 Microprocessor Knees:** 36-months if mandatory service checks are met.

- **QUATTRO:** No required service checks. Extended 2- and 3-year warranty options available when purchased within 12 months of the original invoice date.
- **Plié:** Mandatory service checks at 12 and 24 months. Extended 2-year warranty is available when purchased within 12 months of the original invoice date.
- **Allux:** Mandatory service check at 24 months of original invoice date. Extended 2- and 3-year warranty options available when purchased within 12 months of the original invoice date.
- **SYNSYS:** 36 months warranty with mandatory service at 24 months. Extended 3 year warranty when purchased within 12 months of the original invoice date and mandatory servicing at 48 months.

**3.2.5 Mechanical Knees:** 36-months

**A. Exceptions:**

- Symphony: 24-months
- EasyRide: 12-months

**3.2.6 Structural Components:** 36-months

**3.2.7 Socket Technology:** No Warranty

**A. Exception:**

- Keasy Cones: 24-months

**3.2.8 Orthotics:**

- Straps: 6-months
- Joints: 12-months

**3.2.9 Fabrication Supplies:** 3-months

**3.3 Exclusions:** The warranties set forth herein do not cover the battery, battery charger, adapters and optional accessories (each of which are covered under separate warranty), or test sockets, nor do they cover any alteration, repair or substitution of other parts that, PROTEOR’s judgment, materially or adversely affects the product or part, damage due to accidents, cosmetic damage, water damage deemed as abuse, neglect, misuse or operation beyond capacity, or parts damaged by improper installation.

DISCLOSURE: THE FOREGOING WARRANTIES ARE IN LIEU OF ALL WARRANTIES, EITHER EXPRESS OR IMPLIED, WRITTEN OR ORAL, INCLUDING WITHOUT LIMITATION, ANY IMPLIED WARRANTY OF MERCHANTABILITY OR FITNESS FOR A PARTICULAR PURPOSE, OR OTHERWISE, AND OF ANY OTHER OBLIGATION ON THE PART OF SUPPLIER. THE SOLE AND EXCLUSIVE LIABILITY OF SUPPLIER HEREUNDER SHALL BE TO REPLACE, REPAIR OR REFUND THE PURCHASE PRICE OF A DEFECTIVE PRODUCT, AS DESCRIBED ABOVE. NO WAIVER, ALTERATION, OR MODIFICATION OF THE FOREGOING WARRANTIES SHALL BE BINDING AGAINST SUPPLIER, UNLESS IT IS IN WRITING AND SIGNED BY AN AUTHORIZED EXECUTIVE OFFICER OF SUPPLIER.



## CONTACT INFORMATION

### Customer Service

PHONE: 855.450.7300

EMAIL: [info@proteorusa.com](mailto:info@proteorusa.com)

HOURS: Monday-Friday, 6AM-4PM PST

### Technical and Clinical Support

PHONE: 855.450.7300

EMAIL: [support@proteorusa.com](mailto:support@proteorusa.com)

### Placing Orders

CALL: 855.450.7300

EMAIL: [orders@proteorusa.com](mailto:orders@proteorusa.com)

ONLINE: [shop.proteorusa.com](http://shop.proteorusa.com)

©2024 PROTEOR V23 05.2024

#### Arizona

1236 West Southern Avenue  
Suite 101  
Tempe, AZ 85282

### PROTEOR

#### California

3 Morgan  
Irvine, CA 92618

#### Utah

425 East 400 North  
Gunnison, UT 84634

### PROTEOR Global Headquarters

#### France

6 rue de la Redoute  
21850 St Apollinaire  
France  
Phone: +33 3 80 78 42 42  
Fax: +33 3 80 71 51 50



1236 West Southern Avenue #101, Tempe, AZ 85282 • 855.450.7300

[shop.proteorusa.com](http://shop.proteorusa.com)     #HumanFirst

## #HUMANFIRST